

SUPER NICK

White Egg Layers



The key to your profit!



NEW
Management
Guide
CAGE-FREE



The key to your profit!



The geneticists and research staff at H&N have worked for many years to produce a layer with an excellent performance. This was achieved by a balanced selection procedure, taking many traits into account, such as egg production rate, liveability, feed efficiency and internal and external egg quality. These traits are the major factors that determine the profitability for an egg producer.

The goal now is to enable H&N Super Nick layers to express their full genetic potential by providing the feed, management and environment they need to obtain optimum performance. This manual outlines management practices that experience has proven to be important and will help producers with recommendations to achieve the best results. In all of types cage, and cage free housing systems good poultry management is the key to success with H&N layers.

Good bird management sometimes requires a little extra effort, but this hard work will certainly be repaid. It is not complicated; it simply requires paying attention to the Management on the farm and the behaviour of the birds, common sense and proper decision-making throughout the lifetime of the flock. This management manual will assist you in making the correct decisions.

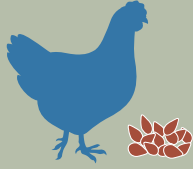

FEED

**Feed intake
between 0 – 20 weeks**
7.8 – 8.0 kg

**Daily feed intake
in production**
110 – 115 g

**Feed Conversion Rate
(kg/kg)**
until 80 weeks 2.03
until 90 weeks 2.05
until 100 weeks 2.09



SUMMARY OF SUPER NICK PERFORMANCE STANDARDS

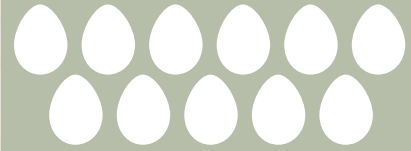

EGG PRODUCTION

Age at 50 % Production
140 – 150 days

Peak Production
94 – 95 %

Period over 90 %
37 weeks

Eggs per Hen Housed
until 80 weeks 371
until 90 weeks 422
until 100 weeks 468

**Cumulative Egg Mass
per Hen Housed**
until 80 weeks 23.2 kg
until 90 weeks 26.5 kg
until 100 weeks 29.5 kg

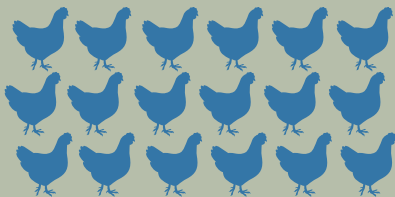

LIVEABILITY

Rearing
0 – 19 weeks 96 – 98 %

Production
19 – 100 weeks 89 – 94 %



BODY WEIGHT

until 19 weeks 1.393 kg
until 30 weeks 1.661 kg
until 72 weeks 1.760 kg
until 100 weeks 1.795 kg



EGG WEIGHT

until 80 weeks 62.4
until 90 weeks 62.8
until 100 weeks 63.1

CONTENT

- 6 EQUIPMENT FOR CAGE-FREE SYSTEMS**
 - 6 Types of rearing system
 - 10 Types of cage-free production systems
- 14 HOUSE PREPARATION AND ARRIVAL OF CHICKS**
 - 14 Cleaning and disinfection procedure
 - 15 Stocking density
 - 15 Pre-Heating the rearing house
 - 16 Rearing house preparation
 - 17 Aviary rearing preparation
 - 18 Chick housing
- 19 BROODING (1 – 21 DAYS)**
 - 19 Brooding lighting program
 - 20 What do chicks need during the first week?
 - 24 Beak treatment
- 26 GROWING (3 – 9 WEEKS)**
 - 26 Light program
 - 26 Design your light program in six steps
 - 30 Training pullets in cage-free rearing
 - 31 Pullet development
 - 32 Feed intake
 - 33 Feathering
 - 35 Perches
- 36 REARING PERIOD (10 – 17 WEEKS)**
 - 36 Body weight
 - 36 Feed intake training
 - 37 Water training in row systems
 - 37 Midnight lighting
- 38 TRANSFER (16 – 17 WEEKS)**
 - 38 Preparing the breeding flock to move to the laying house
 - 38 Stocking density in the laying house
 - 39 Transport to the laying house
 - 40 Housing in the production house
- 42 ONSET OF PRODUCTION (18 – 25 WEEKS)**
 - 42 Period after transfer
 - 42 Activity material
 - 43 Light program and light intensity
 - 44 Sexual maturation and onset of lay
 - 45 Management to the production peak
 - 46 Nest management
 - 47 Onset of lay
 - 48 Stress monitoring in layers
 - 48 Feeding layers during production
 - 49 Floor & System eggs
- 50 PRODUCTION PERIOD (25 – 100 WEEKS)**
 - 50 Production stage
 - 50 Production monitoring
 - 51 Laying process
 - 51 Egg Collection
 - 52 Nest Management
 - 52 Feather covering
 - 52 Feather pecking
 - 53 Keel bone fractures
 - 53 Piling
 - 55 Troubleshooting
- 55 PRODUCTION UP TO > 100 WEEKS**
 - 55 Eggshell quality
 - 55 Good liver health
 - 55 Reduce the metabolic challenges
 - 56 Improve gut health
 - 56 Factors influencing egg size

CONTENT

57 EGG QUALITY

- 57 Eggshell quality
- 59 Albumen quality
- 59 Yolk quality

60 FREE-RANGE & ORGANIC PRODUCTION

- 60 Free-range & Organic production
- 62 Range management

63 NUTRITION

- 63 Rearing Nutrition
 - Feed description and management
 - Nutrient requirements
 - Formulation tips
- 66 Hybrid feed for onset of lay nutrition
 - Feed Description and management
 - Nutrient requirements
 - Formulation tips
- 67 Laying nutrition
 - Feed Description and management
 - Nutrient requirements
 - Formulation tips
- 74 Feed structure
- 74 Feed quality

75 HOUSE ENVIRONMENT

- 75 Hen Thermoregulation
- 76 Temperature
- 77 Hot climate
- 79 Ventilation systems
- 80 Natural ventilation
- 80 Air quality
- 81 Water quality
- 84 Light

85 BIRD ASSESSMENT

- 85 Pullet phase
 - Body weight and uniformity
 - Mortality
 - Shank length or keel length
- 86 Laying hens
 - Body weight and uniformity
 - Mortality
 - Efficiency parameters
 - Egg production

88 HEALTH AND BIOSECURITY

- 88 What is a healthy hen?
- 89 Biosecurity program
- 89 Biosecurity types
 - Conceptual biosecurity
 - Structural biosecurity
 - Operational biosecurity
- 90 Biosecurity program in seven steps
- 94 Vaccination programs
- 95 Administering vaccines in practice
- 96 Vaccine monitoring
- 96 Coccidia
- 97 Internal parasites

98 PERFORMANCE GOALS

- 98 Performance of the H&N Super Nick layer to 100 weeks of age

EQUIPMENT FOR CAGE-FREE SYSTEMS

- ▶ Several rearing / production housing systems are available for layers. There is potential to grow a quality pullet and achieve high productivity in all of them but each one has its advantages and disadvantage.
- ▶ No matter what the housing system is, a key point for success is to respect the stocking density.
- ▶ Training the pullet in the best manner for the production system is crucial in cage free.

IMPORTANT

- ▶ Plan the rearing period with all those involved in the rearing and production periods.
- ▶ Train the pullets needed for the layer house.
- ▶ You can train the pullets too much or not enough!
- ▶ The more closely the rearing facility resembles the future production system, the easier it will be for the pullets to settle down in their new environment after being transferred to the laying house.
- ▶ Please note that the acceptance of these systems can be different in each country (rules from governments, animal welfare organizations and retailers!).

TYPES OF REARING SYSTEM

Barn systems with full litter

- In this system the pullets stay from day 1 till end of rearing on full litter.
- Feeders and drinkers stay on the litter level for the whole rearing period.
- Exception: Additional in this type of rearing, use perches and/or in height adjustable slats to train the pullets to jump by 3 weeks of age.
- In the night all the pullets sleep in the litter.

Learn more about
dimming program
in cage-free systems
(see page 28)

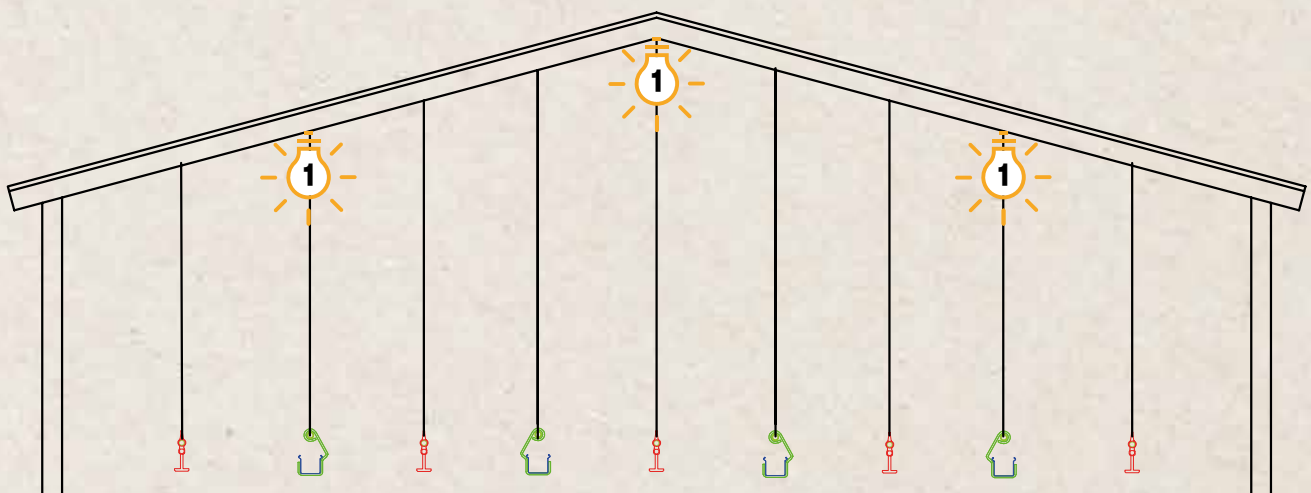

EQUIPMENT FOR CAGE-FREE SYSTEMS

Barn systems with full slats

- In this type of rearing is No litter area, and the pullets don't have access to litter material.
- Exception: Additional in this type of rearing can be the use of perches and/or in height adjustable slats to train the pullets to jump by 3 weeks of age.

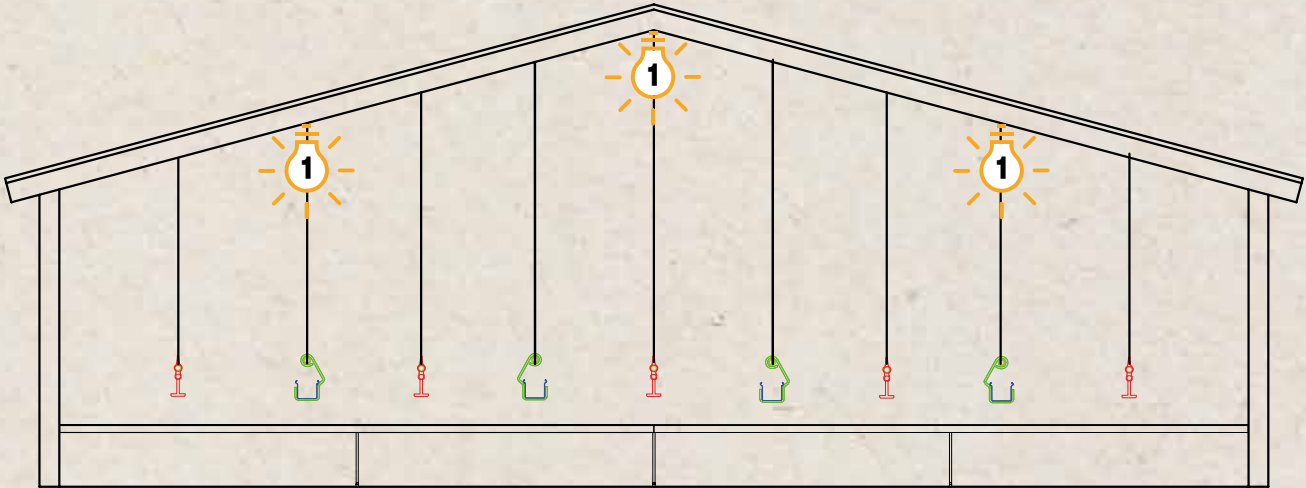

Barn systems with $\frac{2}{3}$ slats above litter pit and $\frac{1}{3}$ litter area

- In this type of systems, the chicks stay 3–4 weeks on the slats, and then they have access to the litter area.
- In these types of systems, you train all the pullets to sleep on the slats and not in the litter during night.
- Feeders and drinkers are mostly placed all on the slats.
- Exception: Additional in this type of rearing can be the use of perches and/or in height adjustable slats to train the pullets to jump by 3 weeks of age.

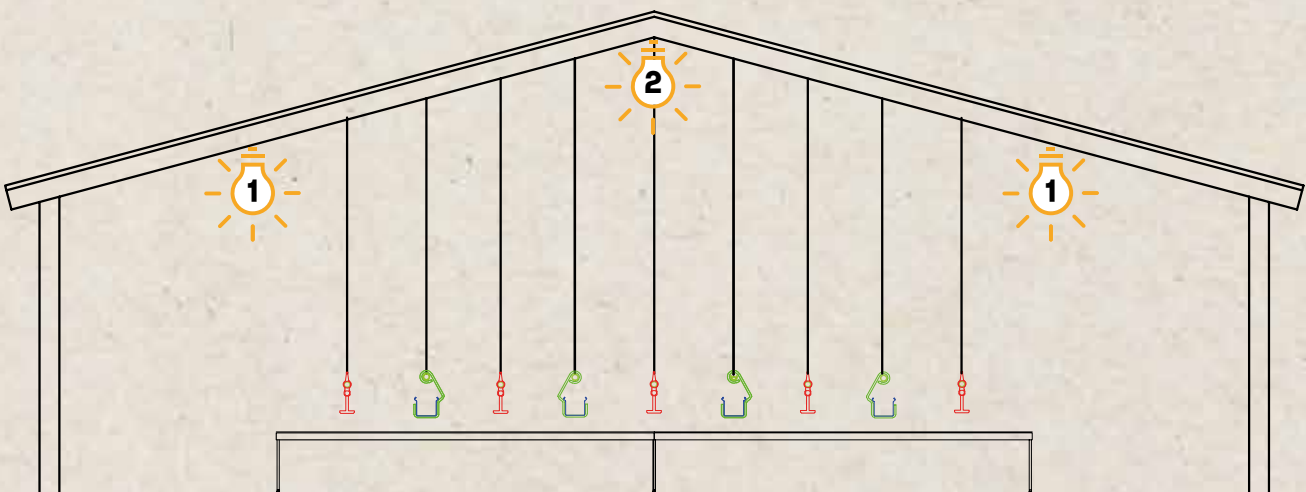

EQUIPMENT FOR CAGE-FREE SYSTEMS

Aviary row-systems

- These types of rearing systems have more than one level living space, they are also called Multi-Tier systems.
- It can be anywhere from 2 to 4 levels.
- The first two levels mostly used to house the DOC and have water and feed on each level.
- A few weeks after housing the DOC, the birds get access to litter area and other levels.
- In these row-systems all the pullets sleep during the night inside the system.
- Point of attention in these systems is to train the pullets how to use the different levels and learn to jump.
- Most of these aviary row systems give no access for the chicks under the system, and light bulbs (1) are not needed.
- **Because of the availability of water and feed on the same level during whole rearing period, there is a risk that some birds never learn to jump during the entire rearing period! Water training programs can be used to require the birds to find their way to different levels to find feed and water.**
- These types of systems can also be equipped with an adjustable slat with an additional drinking line in the litter area between the rows. With this additional slat/ drinking line, the water training program would be much more save to-do.
- Make sure the system is equipped with minimum 5–7 cm perch per bird.
- Make sure that the litter area between the rows is > 2 meters.

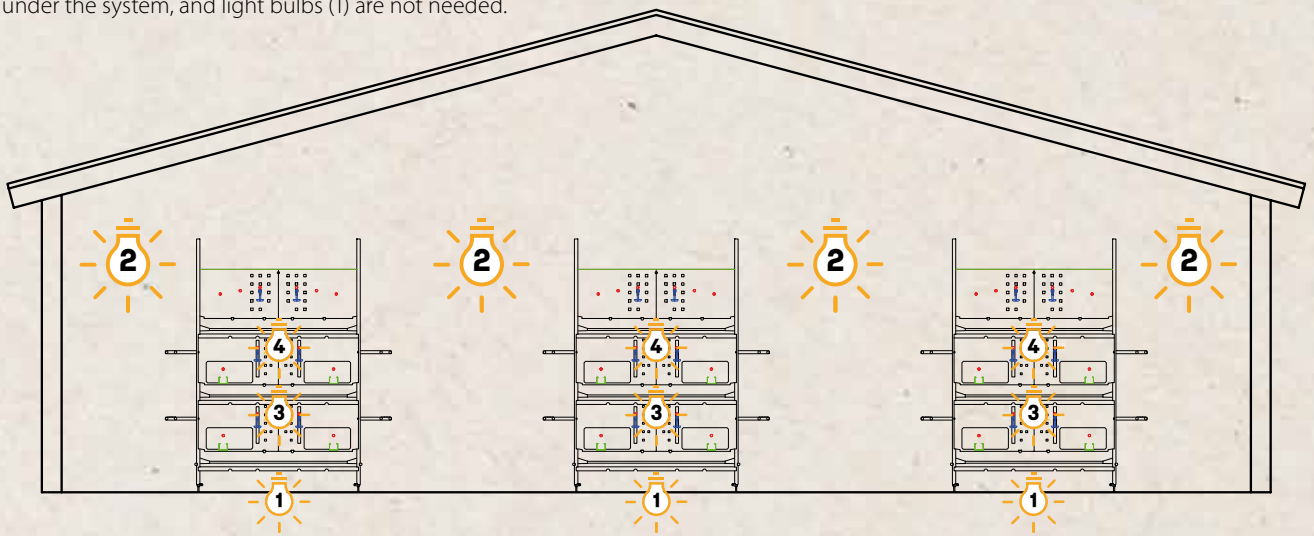

Aviary row-systems within height adjustable slats inside the system

- These types of systems have adjustable slats with nipple drinkers.
- With this slat/nipple drinker the start of training the birds to jump can start on an earlier age inside the system.
- With these types of systems, you can train 100 % of the pullets to jump in the rearing period!
- Make sure the system is equipped with minimum 5–7 cm perch per bird.

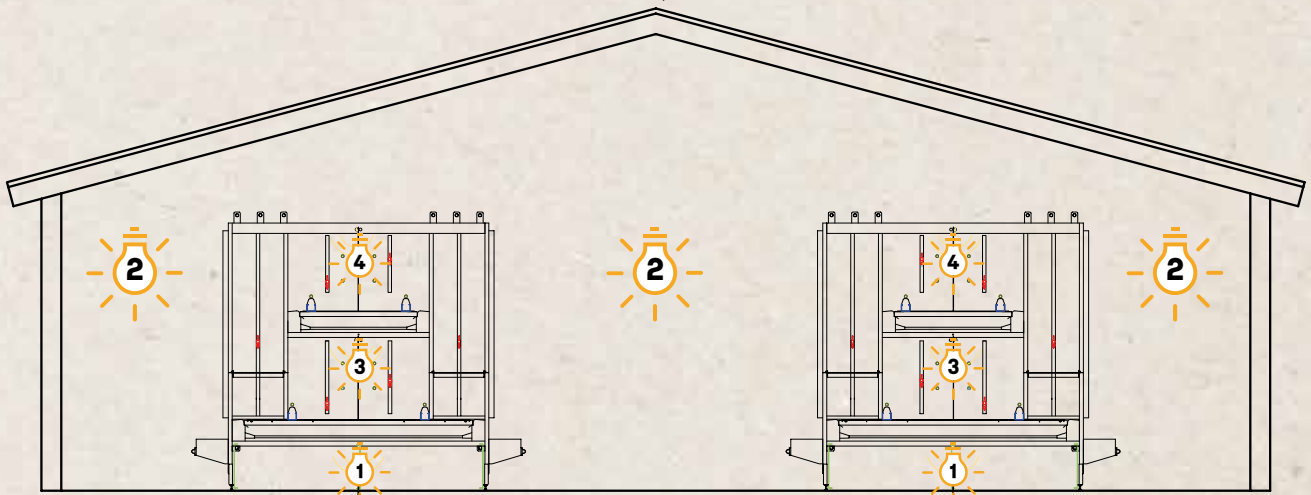

EQUIPMENT FOR CAGE-FREE SYSTEMS

Aviary systems with in height adjustable slats

- Most of these systems have $\frac{2}{3}$ slats above litter pit or manure belts and $\frac{1}{3}$ litter area for the pullets.
- In these types of systems, you train all pullets to sleep on the slats and not in the litter during night.
- Most of these systems (Jump-Start/Nivo-Varia) work with stepless in height adjustable slats to train the pullets to jump between different levels (feed/water)
- With these types of systems, you can train 100 % of the pullets to jump in the rearing period!
- Make sure the system is equipped with minimum 5–7 cm perch per bird.

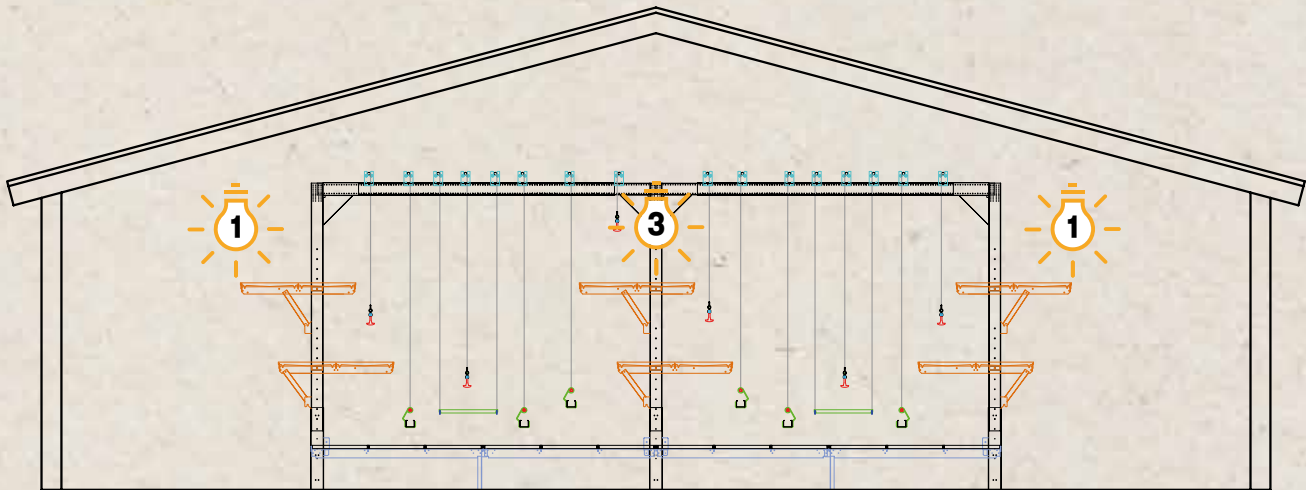

EQUIPMENT FOR CAGE-FREE SYSTEMS

TYPES OF CAGE-FREE PRODUCTION SYSTEMS

- ▶ We see many different brands and styles of cage-free production systems.
- ▶ We will do an overview of some of the most common systems.
- ▶ All these types of systems can also be used for free-range and organic production.
- ▶ Please note that the acceptance of these systems can be different in each country (rules from governments, animal welfare organizations and retailers!).

Barn system with full litter and nest boxes placed in the middle, or side of the house

- Use additional perches in these types of system to give birds more room to find the way to feed / water / nest boxes, and a place to rest.

The best kind of rearing you need for this type of production

- Barn system with full litter
- Barn system with full litter with perches or adjustable slats

Other possible rearing:

- Barn with $\frac{2}{3}$ slats, and $\frac{1}{3}$ litter
- Aviary systems within height adjustable slats
- Aviary row-systems
- Aviary row-systems within height adjustable slat inside the system

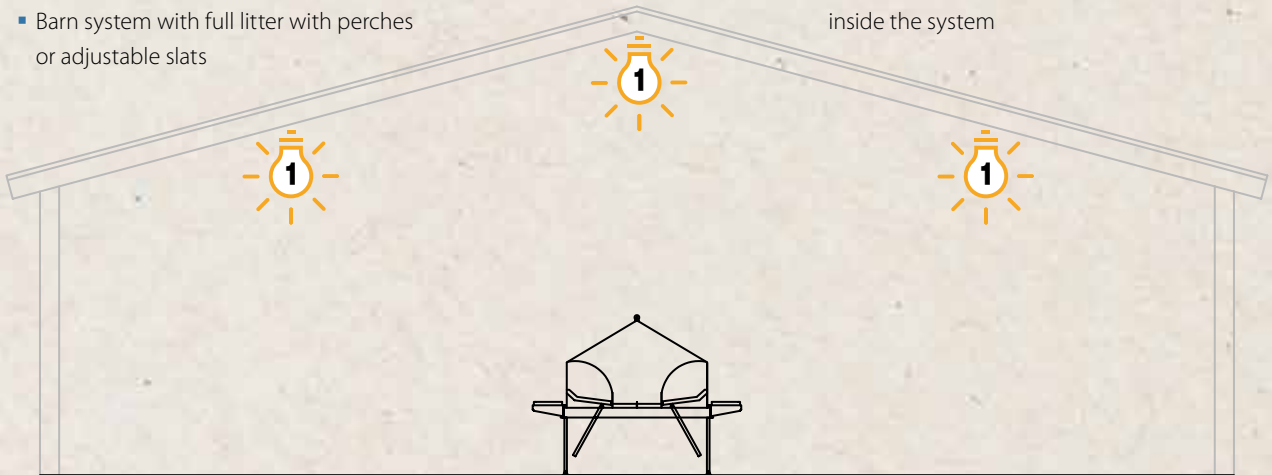

Barn system with full slats and nest boxes placed in the middle, or side of the house

- Use additional perches in this type of system to give birds more room to find the way to feed / water / nest boxes, and a place to rest.

The best kind of rearing you need for this type of production

- Barn systems with full slats
- Barn with $\frac{2}{3}$ slats, and $\frac{1}{3}$ litter

Other possible rearing:

- Aviary systems within height adjustable slats
- Aviary row-systems
- Aviary row-systems within height adjustable slat inside the system
- Cage rearing

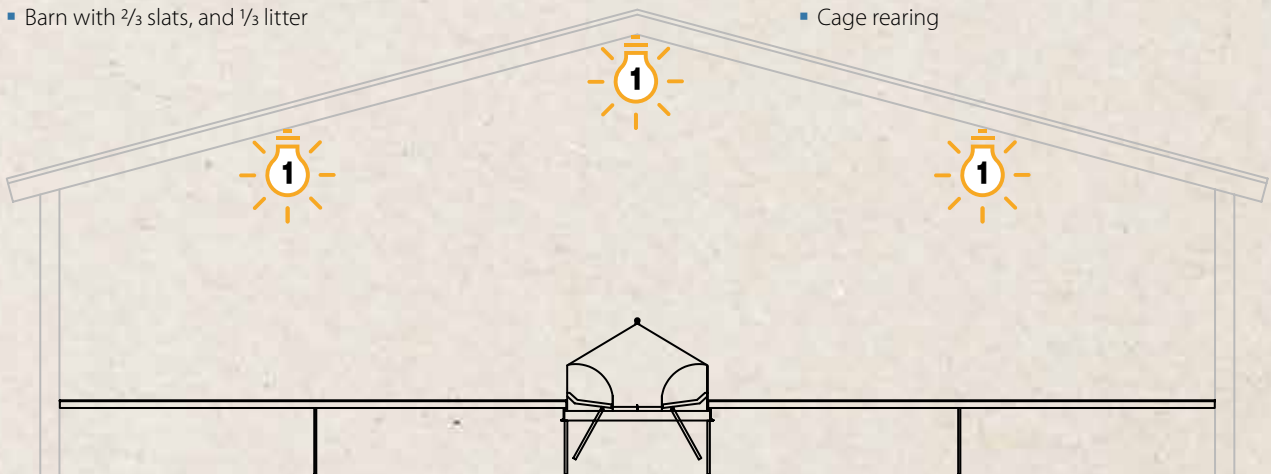

EQUIPMENT FOR CAGE-FREE SYSTEMS

Barn system with $\frac{2}{3}$ slats, and $\frac{1}{3}$ litter and nest boxes on the slats and/or side of the litter area

- Use additional perches in this type of system to give birds more room to find the way to feed/water/nest boxes, and a place to rest on the slats.
- Feed/water/nest boxes are placed on the slats, and the birds also sleep on the perches over the slats.

The best kind of rearing you need for this type of production

- Barn with $\frac{2}{3}$ slats, and $\frac{1}{3}$ litter
- Aviary systems within height adjustable slats
- Aviary row-systems
- Aviary row-systems within height adjustable slat inside the system

Other possible rearing:

- Barn system with full litter
With the use of this type of rearing you need to make some preparations before transfer to lock the pullets up on the slats for a few days.

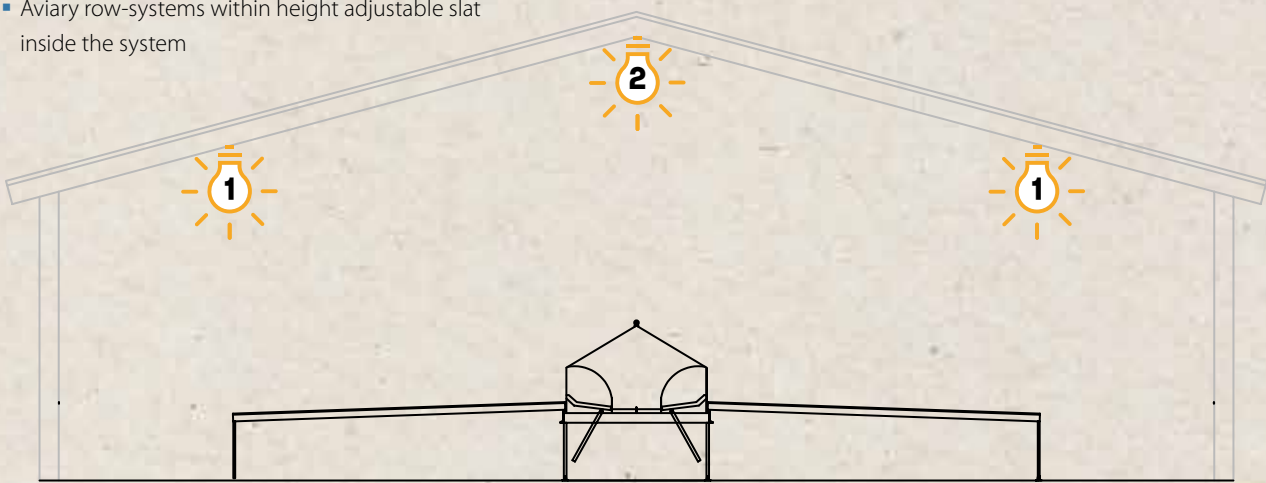

Aviary systems with feed / water / nest boxes on the same level

- With this type of production, the layers can find all they need on the same level (feed, water, nest boxes).
- We would advise to train the pullets to jump between different levels in the system to have a more uniform spread in the production house.
- Try to use additional perches in this type of system to give birds more room to find the way to feed/water/nest boxes, and a place to rest.

The best kind of rearing you need for this system

- Aviary systems within height adjustable slats
- Aviary row-systems
- Aviary row-systems within height adjustable slat inside the system

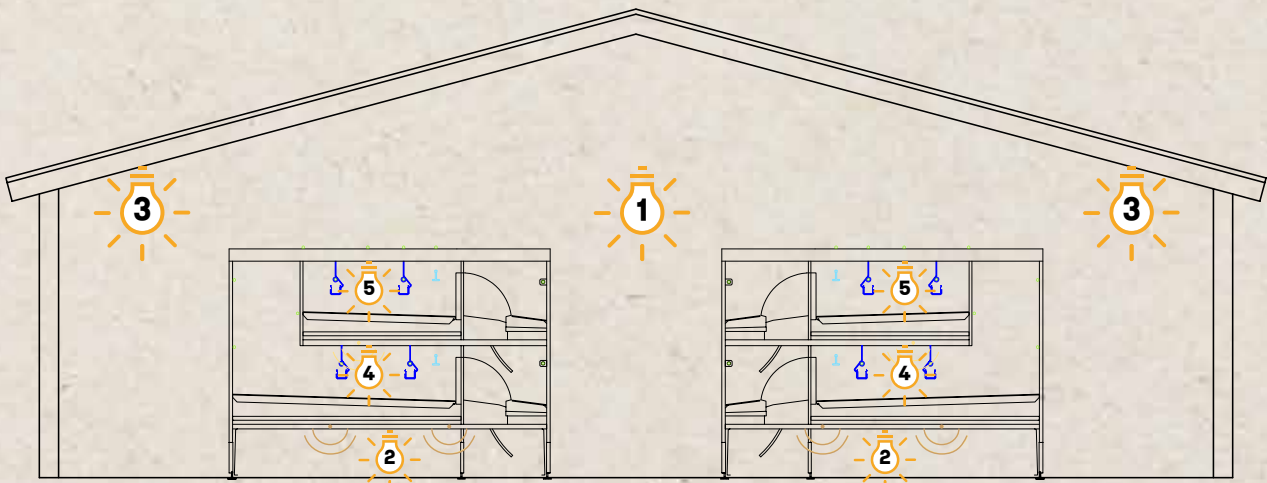

EQUIPMENT FOR CAGE-FREE SYSTEMS

Aviary systems with feed / water / nest boxes on different levels

- With this type of system, the layers must jump on different levels to find feed / water / nest boxes.
- We prefer to train all the pullets to learn how to move in this type of production system in rearing period!

The best kind of rearing you need for this system

- Aviary systems within height adjustable slats
- Aviary row-systems
- Aviary row-systems within height adjustable slat inside the system

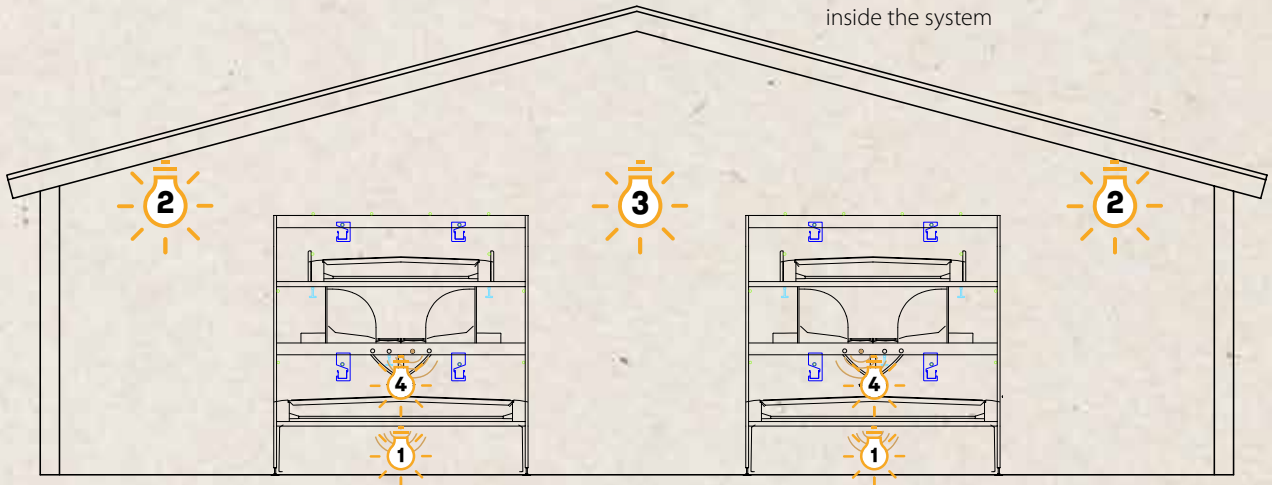

WHAT KIND OF REARING SYSTEM & TRAINING PROGRAM YOU NEED

Try to plan ahead to use the best type of rearing system for the layer house.

Here are a few important questions to think about when making this decision:

What kind of feeding system and drinking system you use in production?

When pullets learn to drink and eat from the same feeding / drinking system, it would give the less stress after transfer to find and use the feed / water in production house.



When there is rearing with feeding pans, and production is with feed chain, the bird could be scared to see the feed moving in the feed chain.



Moving pullets from open drinkers to nipple drinkers there would also be a problem because they haven't learned how to use the nipple drinkers.

Is feed, water, nest boxes on the same level in production system?



When you transfer pullets to production systems with feed, water, nest boxes on one level keep in mind that you don't have to use a water training program in rearing to force the pullets to find the different levels.

Do the birds need to move on slats in production house?



When you transfer pullets from full litter to production system with slats that they need to use for sleep, and to find feed, water or nest boxes, you could see some problems because they don't like to walk on slats.

There is more risk of the layers sleeping in the litter area because they are used to doing this in the rearing period. It can increase the risk of floor eggs.

Do birds need to jump on perches, to find the different levels?

Look how the layers jump to the different levels in the production system.

- **When they need to jump on perches to go to another level, the pullets need to be trained also for all the 100 % to jump on a perch!**
- Chicks should have access to perches by 3 weeks of age.
- Provide minimum 5–7 cm perch space per pullet in rearing.

EQUIPMENT FOR CAGE-FREE SYSTEMS

What is the maximum jump height that the bird needs to make?

With the use of rearing systems with adjustable slats, it is important to know what the maximum height is that they need to jump in the production system.



For here we can say, don't train to less, and don't train to much!

Are there any manure belts in the production system?



When the rearing is without use of manure belts, and you transfer these pullets to a production system with manure belts, you can see some anxious reaction of the layers in the first time's that you are going to use them.

Advise to collect the manure in the first week in evening/night when light is off!

Do birds need to jump in production system to go and find feed, water, nest on different levels?

For this type of system(s) you need a 100 % well trained flock pullets.

With a rearing system with use of adjustable slats to separate water and feed from each other you can train these pullets in the right way.

In row-systems you can use a water training program.

The use of a water training program is never without risk and is very important to do this very careful!



Inform the technical people from equipment suppliers, and chick/pullet suppliers to discuss the need, and the use of a water training program!



Key Points

- ▶ **IMPORTANT: Try to find the best rearing system/training with these 7 steps!**
- ▶ Think of for what kind of production system you should prepare pullets and what kind of training the pullets should have to find the way around this production system.
- ▶ Make a plan together with people who are involved to look for the right rearing system / program.



HOUSE PREPARATION AND ARRIVAL OF CHICKS

- ▶ How to prepare the house before the one-day-old chicks arrive.
- ▶ How to house one-day-old chicks.

CLEANING AND DISINFECTION PROCEDURE

STEP 1

Preparation



It is essential to remove all equipment or waste (dead birds, feed, eggs, manure, etc.) left in the house before cleaning. Any removable material/ equipment should be detached.



STEP 2

Dry Cleaning



This removes all dust and dry organic material from the house using compressed air, brooms or shovels.



STEP 3

Wet Cleaning



This removes all remaining organic material and grease. Thoroughly clean using detergent and hot water. Apply foam detergent and leave it to work for the specified time.

STEP 4

Disinfection

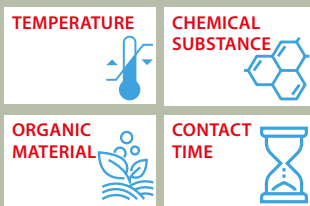

This kills all remaining pathogens that survived the previous steps. For good performance:

- Use only reliable and effective disinfectants.
- Apply the appropriate dose.
- Respect contact time and temperature.
- Follow the label instructions.
- Use appropriate PPE (personal protective equipment).



STEP 5

Fumigation



- Fumigate after liquid disinfection has been completed and the equipment has been installed again.
- Follow the label instructions.
- Use appropriate PPE (personal protective equipment).



STEP 6

Sampling



Sample after cleaning and disinfection, check if the microbiological results are ok. Corresponding sampling and laboratory analysis should be performed: at least eight samples per house should be taken, distributed randomly as shown in table 1. If results are unacceptable, take corrective measures.

HOUSE PREPARATION AND ARRIVAL OF CHICKS

Cleaning and disinfection procedures are key to preventing pathogens from passing from one flock to the next. They also prevent pathogens from challenging birds in their early life. The goal of this procedure is to minimize all microorganisms in the house to offer chicks the best opportunity to achieve optimum performance.

Table 1: Clean and disinfection microbiological results

Place of sampling	Salmonella spp.	Enterobacteria in 16 sq cm	
	Unacceptable	Good	Unacceptable
Wall-floor junction Drinkers Feeders Manure belt Eggs belt Fans	Presence	< 5	> 10



1. Do not proceed to the next step until the previous step has been completed.
2. Clean the area outside the house, storage and service areas, water lines and ventilation system.
3. Provide staff with adequate protection and clothing: masks, gloves, etc.
4. Maintain the cleaning equipment regularly.
5. Pests are under control and you have an active Pest Control Program ready before the chicks arrive.
6. Be sure that there is no disinfectant or insecticide residue left by the chick housing time.

STOCKING DENSITY

An adequate stocking density leads to success in rearing chicks. A high stocking density impacts negatively on daily growth, flock uni-

formity and chick development. Furthermore, a high stocking density combined with reduced feeder space will limit feed consump-

tion, which might already be low under certain conditions (e.g. hot climate or poor feed quality,) and sufficient access to water.

Table 2: Stocking density in rearing farms*

Age	Floor space		Feeder space**		Drinker Space	
	Row-systems	Floor***	Row-systems	Floor	Row-systems	Floor
0 – 3 weeks	140 cm ² /bird	21 birds/m ²	2.5 cm/bird	4 cm/bird 60 birds/pan	1.25 trough cm/bird 12 birds/nipple	1.4 trough cm/bird 12 birds/nipple 100 birds/fountain
3 – 16 weeks	285 cm ² /bird	16 birds/m ²	5 cm/bird	8 cm/bird 30 birds/pan	2.5 trough cm/bird 8 birds/nipple	2.5 trough cm/bird 8 birds/nipple 75 birds/fountain

*This table is a general recommendation and you should adhere to your own country's recommendations.

**minimal recommendations

*** includes all the available space

PRE-HEATING THE REARING HOUSE

Pre-heat the house before the chicks arrive.

Preheat 24 hours before arrival in warm weather and 48 hours in cold weather.

Temperature recommendation Soil: 24 °C Litter: 30 °C Air: 34 °C

Do not only heat the air, but also litter, soil and equipment. Chicks gain and lose temperature easily through conduction (see page 73–74). In case of floor rearing, bring in the litter after preheating to allow the concrete to reach the desired temperature (24 °C).

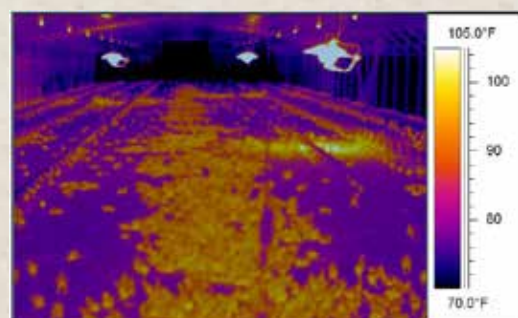

Courtesy of M. Czarick – UGA

HOUSE PREPARATION AND ARRIVAL OF CHICKS

REARING HOUSE PREPARATION

► Floor & Aviary Rearing Systems

Distribute Litter and Paper

Old litter from the previous flock should not be used. Using old litter increases the pressure of disease and may cause increased chick morbidity or mortality. Insoluble grit should be fed if the chicks are on a type of litter (e.g. shavings) that will be eaten by the chicks.

Feeding System

Supplemental feeder trays should be provided within the brooder ring for a few days until all chicks are eating from the regular feeding system. Ensure adequate feeder space is provided.

Cover at least 50 % of the brooding area with paper and scatter feed over the paper.

Drinking System

Chicks must have unlimited access to clean, good quality, fresh water (20–25 °C). During the first days, cups or nipples should be checked and triggered several times per day to stimulate the chicks to drink. Supply additional drinkers which can be easily accessed until the chicks are drinking from the regular water system.

If using nipple drinkers, reduce the water pressure for a few days. This allows droplets to develop which help stimulate the chicks to drink.

Ventilation

Guarantee enough fresh air, but no drafts. With conventional pancake brooders, use chick guards (i.e. new cardboard) to prevent drafts. Start with a diameter of approx. 2 m in cool weather and approx. 4 m in hot weather. Enlarge the ring every couple of days and remove by six or seven days of age.



Rearing prepared for DOC

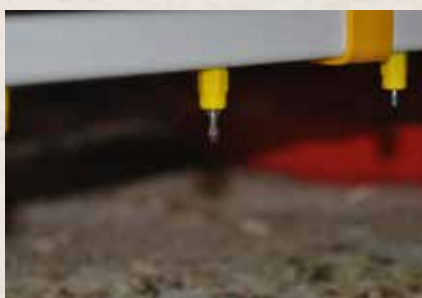

Nipple drinkers



Additional drinkers

HOUSE PREPARATION AND ARRIVAL OF CHICKS

AVIARY REARING PREPARATION

► Aviary Row System

Distribution

Birds are housed at a higher stocking density during the first weeks. To ensure uniform pullet growth, it is important that the birds are moved into the empty cages/levels/litter at the appropriate time and with the correct cage density (see table 2 page 15).

Paper

Cage wires should be covered with paper during the first week of life. Avoid covering the area directly under the drinking system, but cover the surrounding area. In cases where the wire size is too large for day old chicks. Use plastic matting to aid the chicks in reaching the drinkers.

Feeding System

Abundant feed should be provided in the feeders and additionally on the papers inside the cages before the chicks are housed to stimulate feed intake.

When there is a feed chain inside the cage, fill this chain up to 100 % (manual) to reduce mortality when you run the feed chain in the first day(s).

Drinking System (Row & Floor rearing)

360-activated nipples in the brooding cages are preferred (especially with IR treated chicks). If unavailable, provide cup drinkers during the first week. Reduce the water pressure on the nipples to make triggering the nipples easier and attract the chicks by the drop formation.

Flush the lines and cup drinker just before housing the chicks.

Note: the water flow rate in nipple systems depends on the type of drinking nipple system and therefore the supplier should provide the system specific values.



CHECK LIST BEFORE CHICKS ARRIVE

1. Ensure a uniform temperature inside the house.
2. Check the time clock settings and light dimmer settings.
3. Check automatic water and feed systems for correct settings and uniform distribution.
4. Trigger nipples and cups to ensure they are working correctly and also to help stimulate the birds to drink.
5. Coordinate time of arrival with the hatchery and confirm the number and condition of the delivered chicks.
6. Check light intensity with a luxometer.
7. Ensure adequate numbers of trained staff will be on-site for the delivery and unloading.

HOUSE PREPARATION AND ARRIVAL OF CHICKS

CHICK HOUSING

Transport

Transport can have a critical impact on one-day old chick quality. The correct temperature and ventilation levels should be guaranteed during transport. The transport time should be as short as possible. If transport exceeds more than 10 hours, the addition of a hydration product in the crates is recommended. For longer transport it is recommended to use temperature and humidity loggers.

Unloading the Chicks

Place the birds gently but quickly into the house and provide immediate access to water and feed. Crates should be taken into the farm and distributed as soon as possible. Never store crates in conditions that are too hot or cold, windy or in direct sunlight.

With floor brooding, place the chicks directly over the paper and feed. With row aviary brooding place the right number of chicks in each cage.

Chick Quality

On arrival the chicks must be warm and active. Check that there is no abnormal mortality in the crates. The chicks' bodyweight should be measured individually once housing has been completed. Check the body temperature as explained on page 23 and adjust the house temperature.

Record the mortality at housing and inform the hatchery. Also inform them about the chick quality.



Transport truck



Truck unload



Housing DOC



Housing DOC

Key Points

- ▶ Ensure the house has been cleaned and disinfected correctly and on time before chicks arrive.
- ▶ Preheat the house to the correct temperature: Always test at chick level.
- ▶ Observe stocking density recommendations and adapt drinking and feeding systems to the brooding period.
- ▶ House the chicks quickly so they can access water and feed.
- ▶ Take the time to inspect the chicks for body temperature and quality.



BROODING (1 – 21 days)

- ▶ How to promote chick livability during the first week of life.
- ▶ How to promote growth and development of key organs during the first three weeks of life.
- ▶ How to perform effective beak treatment (when allowed) without a detrimental effect on chick growth and welfare.

BROODING LIGHTING PROGRAM

Intermittent Lighting Program

- ▶ Dark houses only (< 3 lux)

This program can be used for up to 7 – 10 days after arrival. Then switch back to the regular step-down lighting program. Using this lighting program has the following advantages:

- Chick behaviour is synchronized; they rest or sleep at the same time.
- Weak chicks will be stimulated by stronger ones to move as well as to eat and drink.
- The behaviour of the flock is more uniform and evaluating the flock is much easier.
- Chick mortality will decrease.

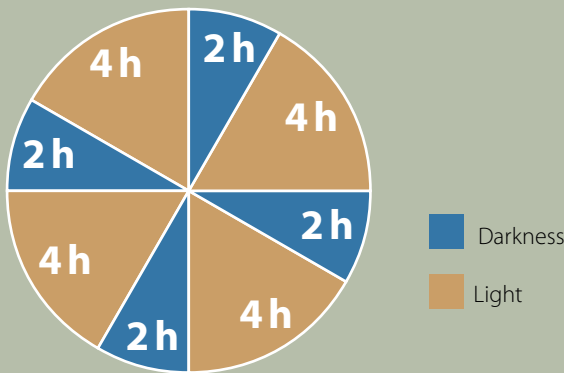

Intermittent lighting program

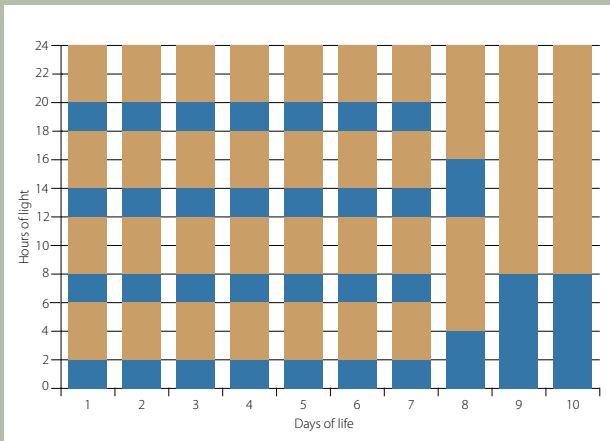

NON-Intermittent Lighting Program

- ▶ All houses

In open houses it is not easy to implement the intermittent lighting program. If this cannot be applied, 22 – 24 hours of light during the first 2 – 3 days is common practice. Providing a dark period during the day to allow the chicks to rest is highly recommended.

In a dark house the light level should be lower than 3 lux when the light-proof system is set. In other words, it must be completely dark.

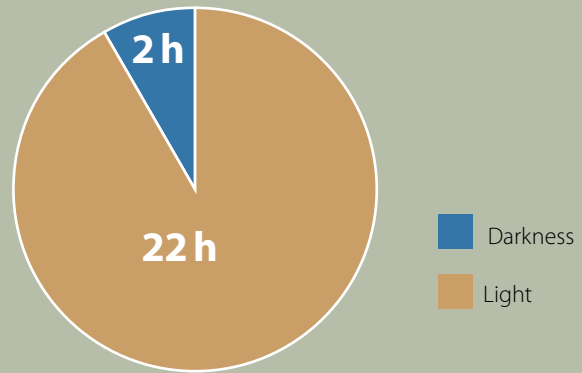

Non-intermittent lighting program

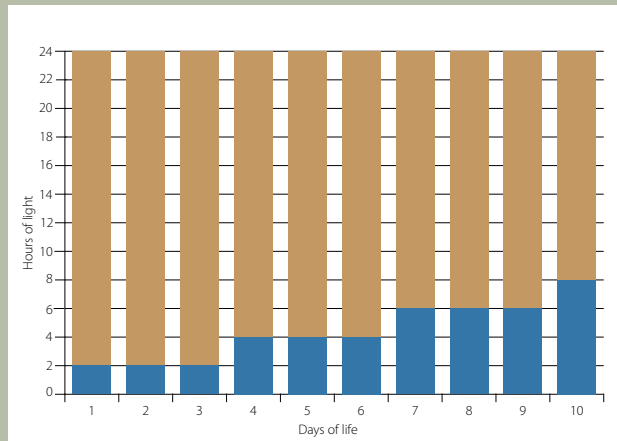

BROODING (1–21 days)

WHAT DO CHICKS NEED DURING THE FIRST WEEK?

Temperature

The temperature should be between 34–36 °C for the first few days (see table 3).

- **Correct temperature:** Chicks will be well distributed and active.
- **Low temperature:** Chicks will group together and sound stressed.
- **High temperature:** Chicks will group in the coldest places, are inactive and pant.

Temperature recommendations:

- House temperature: 34–36 °C
- Paper and/or litter temperature: > 32 °C
- Concrete/ground: > 26 °C

Pasted vents may indicate a too high or too low temperature.

After two or three days, decrease the temperature by 0.5 °C every day. **Be aware that the best indicator is chick behaviour and vent temperature.** Check the flock every time you change your settings.

If the house temperature is not uniform, take corrective measures by changing heaters and ventilation parameters.

When housing the chicks, follow these recommendations:

- Place the smallest chicks in the warmest areas on the floor, or inside the aviary system.
- Place the youngest chicks in the warmest areas or aviary system (if the flock is arriving over several days).
- Avoid placing chicks in very hot spots (near the heaters) or in very cold spots during the first 10 days.
- If most of the chicks are from a young PS flock (younger than 27 weeks), increase the objective temperature 1 to 2 °C (1.8 to 3.6 °F)

Table 3: Temperature recommendation

Type of brooding	Temperature at chicks arrival	Temperature decrease
Aviary systems	34 – 35 °C / 93 – 95 °F	Reduce 3 °C/5 °F each week until supplementary heat is no longer needed.
Floor	35 – 36 °C / 95 – 97 °F	

Correct temperature distribution



Low temperature distribution

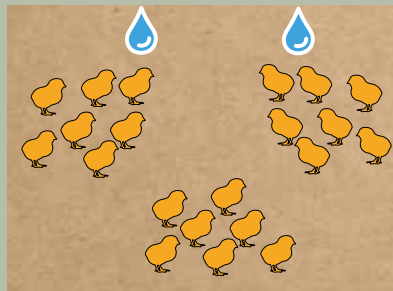

Hot temperature distribution

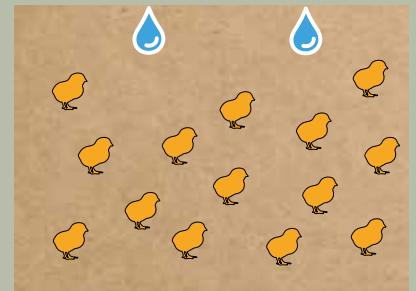

BROODING (1–21 days)

Water

Set the height of the drinkers so the chicks can drink easily.



360-activated nipples are preferable in rearing houses. If not available, and especially with infrared beak treated chicks, we recommend using cups or Auxiliary drinkers at a ratio of 80 to 100 birds per extra drinker during the first 5–7 days. Especially important having extra drinkers when brooding on floor: circle or partial house.



Reduce the water pressure in the drinking system to create a hanging drop at chick eye level.

Follow manufacturer recommendations.

Trigger the nipples or cups during the first 3–4 days to encourage chicks to drink. Flush the lines just before housing the chicks and daily for the first 4 days, and keep water temperature between 20–25 °C (68–77 °F)

Do not give cold water to chicks. Be careful when flushing water lines for chicks. Allow water time to warm up in the facility so chicks are comfortable drinking.



Ventilation

Supply sufficient volumes of fresh air to remove dust and undesirable gases. Ensure sufficient air movement even on cool days (try to keep minimum ventilation of 0.7 m³/hour/kg).

Strong movements of air disturb the chicks, they will avoid using drafty areas. This can negatively impact on chick distribution and activity.

Adequate ventilation is especially important in hot weather.

Draft incorrect



A good brooding period is key to developing the gut, immune system, and the skeleton. This period is therefore crucial to improve flock liveability during the first weeks, and to obtain good quality and productive pullets.

Humidity

Humidity should be at least 60 %. With lower than 40 % humidity, chicks may dehydrate or damage their respiratory tract.

Adjust temperature according to relative humidity. For instance, the temperatures in this section are set for a humidity between 60–70 %. Above 80 % the comfort-

able temperature reduces by 1 °C and below 40 % increase by 1°C.

In aviary row systems, and systems where you don't use the litter area the first 3 weeks, you can use these litter/concrete areas to spray water to get the right humidity when this is too low!



Fog installation in rearing house

BROODING (1 – 21 days)

WHAT DO CHICKS NEED DURING THE FIRST WEEK?

Feed

Good quality feed should be available for chicks immediately after placement. Correct feed structure is also extremely important (see page 61). Feed should be scattered on the paper and renewed during the first 3 – 5 days. Place abundant feed in the feeders to attract the chicks.

With use of feed chain or open auger, be aware that chicks can get stuck when you run the feeders the first time(s)

Keep a high level of feed the first days/week.

There are different tools to prevent this:

- Slow starter feed chain
- Tools to remove the chicks out of the

feed chain during running. (sometime a simple sponge can work perfect for that ...)

Discuss with the equipment supplier the best way to reduce mortality because of that, and the use of the right tools.



Chick saver in aviary rearing to prevent that DOC moving in the running feed chain



Use of sponges in aviary row systems for good distribution of DOC in first days



Good distribution of DOC in the first days

Light

Light should be spread uniformly throughout the entire area where chicks are.

Light intensity between 40–60 Lux during the first week inside the aviary row system, or litter/slat area measured at drinker level. Light should be spread uniformly throughout the entire aviary system. It is important to avoid shady and dark areas in the brooding levels.

When the chicks are 14 days old, we start with a dimming period at the end of lighting program (see page 28, Step 6).

This could be done with some automatic dimmers on the light, or to switch of the different types of light in different steps.

This to prepare the chicks for the time that they get access to the litter area 1 or 2 weeks later, and bring them on the slats, or inside the aviary system at the end of the lighting program.

With this 15–20-minute dimming period they get the time to find their way up to the slats, or into the aviary system.

Ask your equipment supplier, or chick supplier how to make this dimming period in the right way.

Keep always an eye on chick behaviour (pilling up) when you start with this change in lighting program!



BROODING (1–21 days)

HOW DO YOU KNOW THAT EVERYTHING IS RUNNING SMOOTHLY?

Crop Fill Measurement

Crop fill measurement is a good tool to check if the chicks are eating in the first two days of life.

1. Sample around 100 chicks.
Take them randomly from around the house to ensure a reliable overview.
2. Gently feel the crop.
3. The crop should be full, soft, and rounded in started chicks.
4. Check the result according to the time after placement.

If the result is below target, check the brooding conditions, and take corrective measures.

Correct crop filling



Incorrect crop filling



% of chicks with feed in the crop

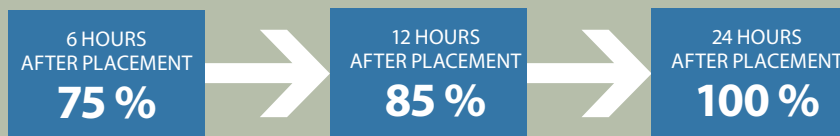

Behaviour

PAY ATTENTION TO YOUR CHICKS!!!

Chicks cannot talk but they send you many signals:

- Check their distribution
- Check their activity
- Check the water and feed intake
- Check what kind of sound they are making
- Check if they look happy!!!

Body weight

The body weight at the end of the first week must double the body weight at placement and uniformity must be > 80 %. In case, these goals are not achieved, a review of managements (drinking or feeding management, temperature, etc) and nutrition must be performed.

Cloacal Temperature

Chick temperature is between 40–41 °C (104–106 °F) after the moment of full homeothermy. During the first week of life chicks are unable to control their body temperature and it varies according to the ambient temperature. This information can be used to adjust house temperatures optimally.

Use modern ear thermometers (see picture).

1. Make sure you collect samples of chicks from different parts of the house. Sample chicks distributed throughout the house for reliable readings. Circle or spot brooding take temperature of 4–5 chicks per circle. In floor/slat/aviary brooding 60 samples (20 front, 20 middle, 20 back side of the house)
2. Check their cloacal temperature.

3. Collect the information, calculate the average and adjust the house temperatures accordingly to achieve optimal chick temperatures for all the chicks. Adjust the environmental set point or temperature : + or – (0,5 °C) (1 °F) per 0,3 °C (0,5 °F) above the upper limit or below the lower limit of optimal vent temperature.

Important!

A chick's body temperature does not correlate with the current temperature but with the temperature of the last few hours.

40.0 °C
104.0 °F



41.0 °C
106.0 °F



BROODING (1–21 days)

BEAK TREATMENT

Beak treatment* is an important cannibalism/pecking prevention measure in poultry management, especially in open houses with high light intensity. While various methods of beak treatment may be used: the objective is to treat the beak on the right time in a uniform manner that will permanently

retard future beak growth. Improper beak treatment procedures may result in permanent damage to overall flock performance. Take care for a higher level of feed in your feeder a few days/weeks after beak treatment to reduce pecking on an empty feeder/chain.

Infrared Beak treatment (IRBT) of day-old chicks

The beaks of day-old chicks can already be treated at the hatchery using infrared technology. This method can provide more uniform beak treatment because it is performed by a machine and not by different crews.

The beak remains intact until 10–21 days and then the treated portion separates. Because of this process, chicks will need extra care during the brooding period.

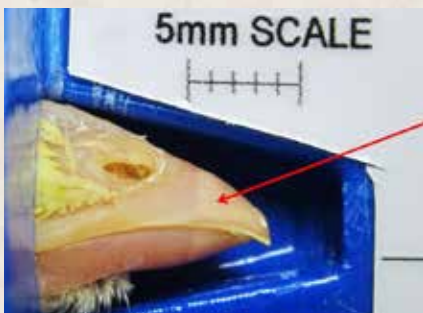

1 day old*



14 days old*



21 days old*



56 days old*



56 days old without beak treatment*

Please remember that country-specific regulations should be observed.



*Please note that there are countries where is a ban on any kind of beak treatment!

PAY ATTENTION TO:

- **Drinking water:** It is vital to encourage the water intake in the first days. Preferably use 360-activated nipples as they are easy for chicks to use. Additional cup drinkers are also preferable. If bi-directional nipples are the only option, providing additional cup drinkers is obligatory.
- **Light:** Ensure the light level in the drinker area is minimum 40–50 lux for 3 to 5 days.
- **Feed:** Scatter feed on paper until day 7, and take care for a higher level of feed in your feeder a few days/weeks after beak treatment to reduce pecking on an empty feeder/chain.

*Pictures courtesy of Novatech®

If you would like to have more information about this treatment please contact your regional Novatech® representative.

BROODING (1–21 days)

7–10 day Beak treatment

The conventional method of beak treatment is to treat the beaks with a hot blade.

Beak treatment should ideally be performed in the first 7–10 days. It is a delicate and precise manual procedure.

Ensure these conditions are fulfilled before starting the process:

- **Healthy birds:** If birds are sick or in poor condition, treatment should be delayed until the flock has recovered. Beak treatment in an unhealthy flock can severely damage its viability.
- **Trained crew:** Due to the delicate and precise nature of this procedure, proper crew training is of the utmost importance.

Only allow well-trained crews to perform this procedure. Never hurry the crew especially if they are inexperienced.

- **Adapted equipment:** Hot blade machines are available on the market. For correct beak treatment, the blade temperature should be approximately 650 °C. The blade colour may be used as an indicator. The use of a template with guide hole is recommended to make treatment easier and more uniform. Keeping the machine clean and in good maintenance is vital for good results.
- Check the birds during treatment, and low temperature in 1°C when too many beaks are bleeding.



< 650 °C

650 °C ✓

> 650 °C

And the days after Beak treatment ...

SPECIAL CARE SHOULD BE PROVIDED TO THE CHICKS IN THE DAYS FOLLOWING BEAK TREATMENT:

- Monitor water intake. It will be reduced for 2 or 3 days but then the previous intake should be recovered. Reducing the water pressure in the nipple drinker lines could be useful.
- Use additional (open) drinkers if necessary.
- Increase the house temperature until the chicks seem comfortable.
- Add Vitamin K to the diet or drinking water a few days before and after beak treatment.
- Take care for a higher level of feed in your feeder a few days/weeks after beak treatment to reduce pecking on an empty feeder/chain.

Key Points

- ▶ Focus on water, feed, light intensity, air temperature and humidity during the first week.
- ▶ Check chick behaviour to enable better settings of the brooding conditions.
- ▶ *Implement an intermittent light program if possible, in first 2 weeks and start to implement a dimming period at end of lighting program after 14 days, to start teaching the birds to find place inside the aviary system after open the system.*
- ▶ Perform beak treatment properly and apply special management immediately after treatment.
- ▶ Give the chicks on the right time the space they need (see recommendation on page 15).
- ▶ Always check the regulations from government, animal welfare and retailers in the country!
- ▶ When you distribute chicks from one level to another level in aviary row systems also take some paper to this new level (this with the use of coccidiosis vaccine ...).
- ▶ From week 1 take body weight every week. Always weigh birds on the same day of the week and at the same time of day.



GROWING (3 – 9 weeks)

- ▶ How to set the correct light program in rearing according to your geographical situation, house type and production objectives, how to train the chicks in the right way.
- ▶ How to promote correct pullet growth during this period.
- ▶ How to use the chicks feathering and natural molting pattern to monitor chick development.
- ▶ How to use system and perches in floor / aviary rearing to promote bird welfare, liveability, body development and prevent floor eggs in the future.
- ▶ NEVER provide more space (feeder, drinker and stocking density) later than 3 weeks.

LIGHT PROGRAM

BASIC PRINCIPLES

- The hours of light at the end of rearing should equal the hours of light at the production house before the start of light stimulation.
- The light intensity should be similar to what pullets will find in the production house.

DESIGN YOUR LIGHT PROGRAM IN SIX STEPS

STEP 1

What is the Destination of the Pullets?

- ▶ How many hours of light do you have in your country?

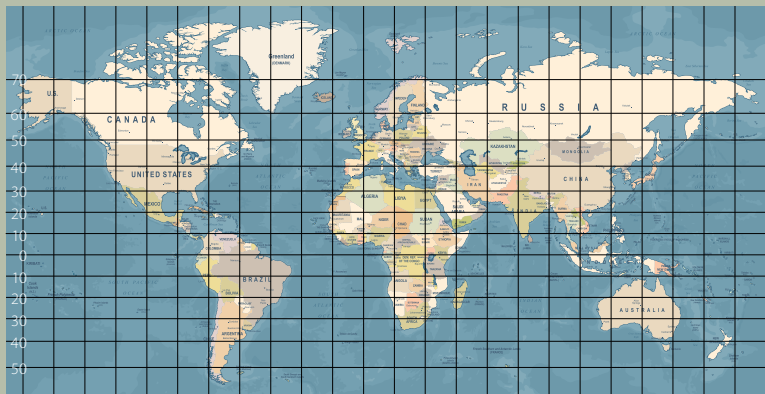

▶ Examples

Country	Hemisphere	Hatch date	Start of lay date	Light hours at start lay
Mexico	20° North	5 th February	June	12 h 29 min.
Peru	10° South	5 th February	June	11 h 35 min.
Senegal	20° North	5 th July	November	11 h 53 min.
Indonesia	10° South	5 th July	November	12 h 31 min.

Hours between Sunrise and Sunset in the Northern and Southern Hemispheres

Northern date	0°	10°	20°	30°	40°	50°	Southern date
5-Jan	12:07	11:34	10:59	10:17	9:27	8:14	5-Jul
20-Jan	12:07	11:38	11:05	10:31	9:47	8:45	20-Jul
5-Feb	12:07	11:44	11:19	10:52	10:19	9:32	5-Aug
20-Feb	12:06	11:50	11:35	11:16	10:55	10:23	20-Aug
5-Mar	12:06	11:58	11:49	11:38	11:28	11:11	5-Sep
20-Mar	12:06	12:07	12:06	12:06	12:07	12:09	20-Sep
5-Apr	12:06	12:14	12:25	12:35	12:49	13:08	5-Oct
20-Apr	12:06	12:24	12:41	13:02	13:27	14:03	20-Oct
5-May	12:07	12:31	12:56	13:26	14:02	14:54	5-Nov
20-May	12:07	12:37	13:08	13:45	14:32	15:37	20-Nov
5-Jun	12:07	12:41	13:17	14:00	14:53	16:09	5-Dec
20-Jun	12:07	12:42	13:20	14:05	15:01	16:22	20-Dec
5-Jul	12:07	12:41	13:19	14:01	14:55	16:14	5-Jan
20-Jul	12:07	12:37	13:11	13:49	14:38	15:46	20-Jan
5-Aug	12:07	12:32	12:59	13:29	14:09	15:02	5-Feb
20-Aug	12:06	12:25	12:44	13:06	13:35	14:14	20-Feb
5-Sep	12:06	12:17	12:26	12:40	12:55	13:16	5-Mar
20-Sep	12:06	12:08	12:10	12:13	12:16	12:22	20-Mar
5-Oct	12:07	12:01	11:53	11:46	11:37	11:26	5-Apr
20-Oct	12:07	11:52	11:36	11:20	10:59	10:31	20-Apr
5-Nov	12:07	11:44	11:20	10:55	10:21	9:36	5-May
20-Nov	12:07	11:38	11:07	10:34	9:51	8:51	20-May
5-Dec	12:07	11:35	10:59	10:19	9:29	8:18	5-Jun
20-Dec	12:07	11:33	10:55	10:13	9:20	8:05	20-Jun

STEP 2

Where will the Birds be transported to and from?

► This determines the number of hours at the end of the program.

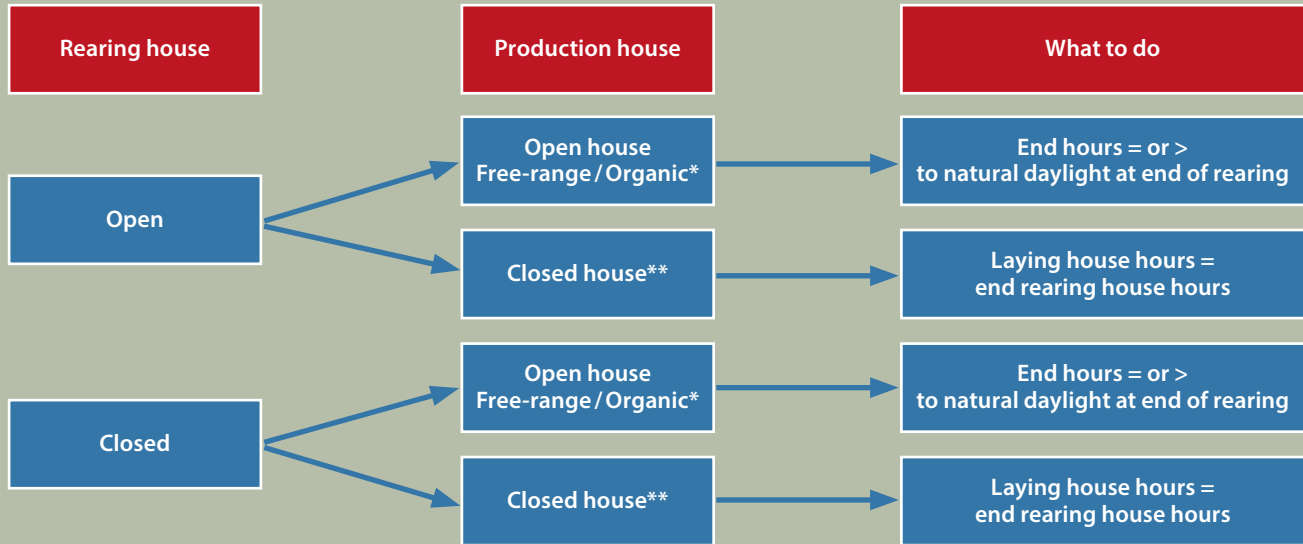

* Open house: any construction where you have > 3 lux. House with free-range/organic production, curtains, or nothing at all.

** Closed house: any construction where you have < 3 lux. House made of panels or bricks.

STEP 3

Number of Hours in the Rearing House

► Depending on limitations in step 1 and 2, determines the optimum end hours for your type of house: open or dark.

Short: ending at 10 – 11 hours / day

- Only in closed house
- free-range and organic production depending on the season.
- Electricity savings
- Concentrate feed intake
- Feed intake challenge

Long: ending at 12 – 14 hours / day

- Open and closed houses
- free-range and organic production depending on the season.
- More time for feed intake
- High electricity cost in close houses

Remember: The hours of light at the end of rearing should equal the hours of light at the production house before the start of light stimulation.

STEP 4

Speed of Light Reduction

► Driven by your market requirements, egg size target and feed intakes.

The light program in laying hens is an essential tool to achieve a specific type of production. This is especially true for egg size as the rearing light program and the timing for the light stimulation, have a greater effect on this parameter.

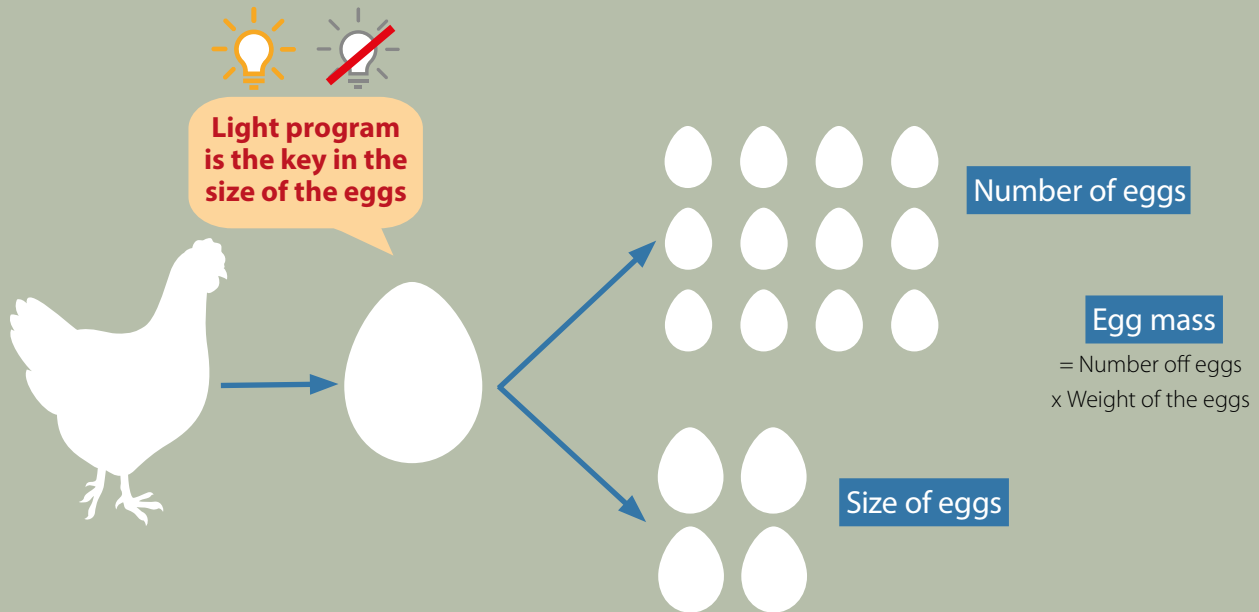

Slow Step Down

- Bigger egg size in production
- More time for feed intake
- Recommended for Hot climates

Fast Step Down

- Higher sensitivity to light, faster start in production
- If it doesn't appear that body weight targets will be met at week 5, it is highly recommended to change to a slower reduction to allow body weights to improve. Once achieved you can return to the fast reduction.

The flocks with light program with slow step down (one hour per week) tend to produce more egg size than those with faster step downs (two hours or more per week).

W	1	2	3	4	5	6	7	8	9	10	...	18
	23	22	21	8	8	8	8	8	8	8	8	10
	23	22	21	20	19	18	17	16	15	8	8	10

Source: Leeson 2005

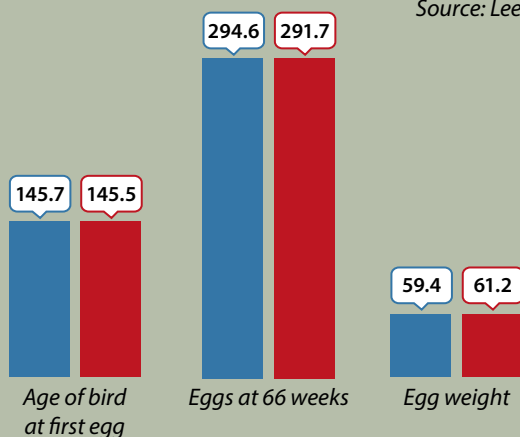

Note that everything described in this chapter is only applicable for birds that reached their standard weight and have had a harmonious development during their breeding phase as explained before.

For more details check out Technical Tip Egg Size:



GROWING (3 – 9 weeks)

STEP 5

Light Intensity at the Destination

► Light intensity should be adapted across the different rearing periods.

On floor/aviary, measure at bird level head, between light bulbs, at drinker and feeder level. Use the lower value to adjust to follow the recommendations.

During the first week a higher intensity is needed to activate the birds.

From 14 days of age, start to use a dimming period of the light for 15–20 minutes at the end of the lighting program, to start training the chicks to find the way back inside the system or on the slats in the evening/night.

After week 5, the light intensity should be decreased to calm the birds and prevent pecking and cannibalism. This is also recommended in open rearing houses and organic rearing.

After 10–12 weeks of age, we would like to have a minimum of 10 lux for white layers, and 15 lux for brown layers, to prevent floor and system eggs in later production period

Light intensity in rearing never should be much lower than what will be expected in the production house.

Always avoid any sharp increases of light intensity after transfer.

Example of lighting program for dark houses

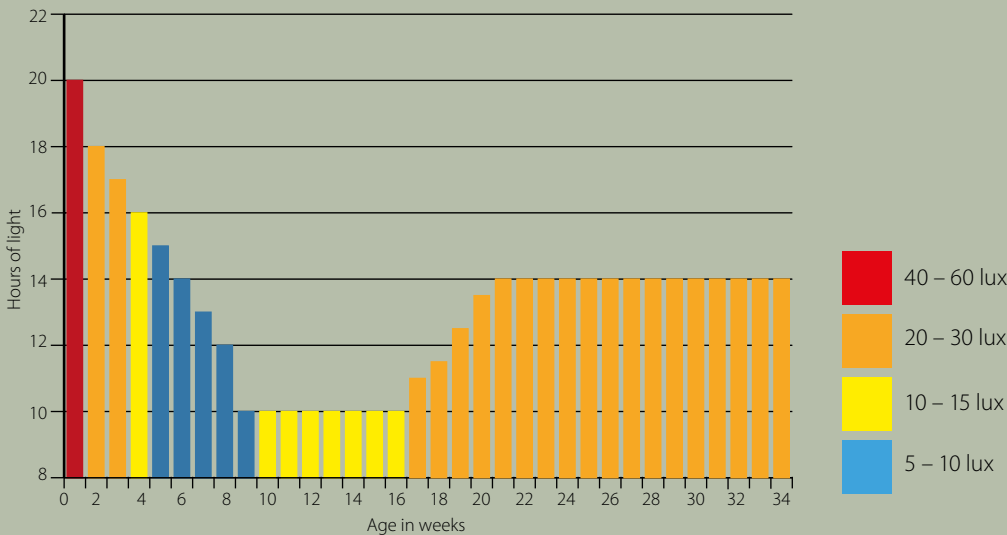

STEP 6

Dimming Period in Rearing / Production

► From 14 days of age, start to use a dimming period at the end of the lighting program.

When chicks are released from the slats/aviary systems at 3–4 weeks of age, they need to be trained to find the way back at the end of the lighting program to stay on the slats, or inside the aviary system during the night.

We can train the chicks for that by switching off different light zones, step by step in a dimming period of 15–20 minutes.

Depending on the rearing system, you need from 2 to 5 steps in turn off the different light points in total 15–20 minutes time (see pictures of different rearing/production systems on page 6 till 12). Start to dim/switch off Light 1 then followed by zones 2-3-4 or 5. By starting at 14 days of age with this program, the chicks are al-

ready used to it and allow an easier transition at the time they are released to the slats/system.

After releasing the chicks and for the first days, you must manually dim the lights to see how much time it takes to the birds come back inside the system or slat area.

It is strongly advised during the rearing period to regularly check every 2 weeks if all birds enter the slats/system at the end of the lighting program.

► Continue this dimming program in the production house right after transferring the pullets!

IMPORTANT

Discuss this dimming program with your technical advisors from your chick and system suppliers.

TRAINING PULLETS IN CAGE-FREE REARING

Release the Chicks to Litter Area

▶ With the use of aviary row systems, $\frac{2}{3}$ slats, and aviary systems within height adjustable slats.

- Depending on the height of the system/dropping pit we start to release the chicks from 3 weeks of age.



Don't keep the chicks locked up too long!

- This can cause problems with stocking density.
- The sooner the chicks have access to litter area/material, the less problems with BAD pecking behaviour in second part of rearing period and production!
- Use litter material no deeper than 1 cm in the litter area.
- Use additional ramps/stairs to help the chicks to find the way inside the system at end of lighting program.
- Open the system/dropping pit 1 hour after start of the lighting program, and let the chicks find their own way out.



Don't release all the chicks out of the system at once!

- Try letting out a few rows of the aviary or one side of the dropping area at a time. This will help limit the number of chicks that will need to be placed back in the system at the end of the day. When this works well after a few days, you can release to other rows, and other side of the dropping pit.
- Settle enough people during the end of the day, at time that lighting program ends.
- With the good use of a dimming program, a lot of chicks will find their way up into the system, or dropping pit by themselves. For sure you need to support them, and help the last chicks up, for the first week every evening.
- In first days, you can use some laser pointers to activate the chicks to jump on the slats, or inside the aviary system.

- Bring the chicks to bed at end of the lighting program!
- Start to provide Alfalfa/Lucerne in the litter area a week after release of the chicks. This gives the farm manager extra eyes to check if everything is on target.
- **When the chicks take this Alfalfa/Lucerne, you need to check your feeding management (select feed intake) or/and feed formula!**



We would like to see 100 % of the chicks up, or inside the system every end of lighting program!



During the whole Rearing Period

- Make sure that all the chicks moving up to the dropping pit, slats, or inside the aviary system during the whole rearing period!
- Reaction on vaccinations or climate can make that during rearing period chicks/pullets move to sleep in the litter area.
- Advise to check this during whole rearing period!

GROWING (3–9 weeks)

PULLET DEVELOPMENT

Pullets show extreme body growth during this period. This is especially true if we consider the percentage of growth compared with the previous body weight.

Even more importantly, at this stage the birds will develop most of their organs, skeletal system and muscles which are essential for their health and performance. Therefore, correct growth during this period is key to having healthy and productive adult birds.

If growth is delayed in this period, further compensatory growth will be impossible for bone frame. The birds can reach the standard weight, but the body development will

differ and hens can become over fattened. Check that you are achieving the correct body weight from week 1 and take corrective measures before it is too late.

Uniformity should be above 85 %.

Change diets if body weight is on the target at the corresponding age: 0 to 5, 6 to 10 and 11 to 17 weeks (see the nutrition chapter) with a uniformity above 80 %. In case you didn't achieve it, delay the change one or two weeks. Also, could delay the change in case of stress events, like vaccinations.

It is very important to achieve the standard body weight during the first 12 weeks of age.

If body weight is too far ahead of the standard, you can change diets faster to ensure they stay on target. If the body weight stays above target during this period, the hens may grow to large, which can reduce feed efficiency.

IMPORTANT 
It is very important to achieve the standard body weight at week 5–6.

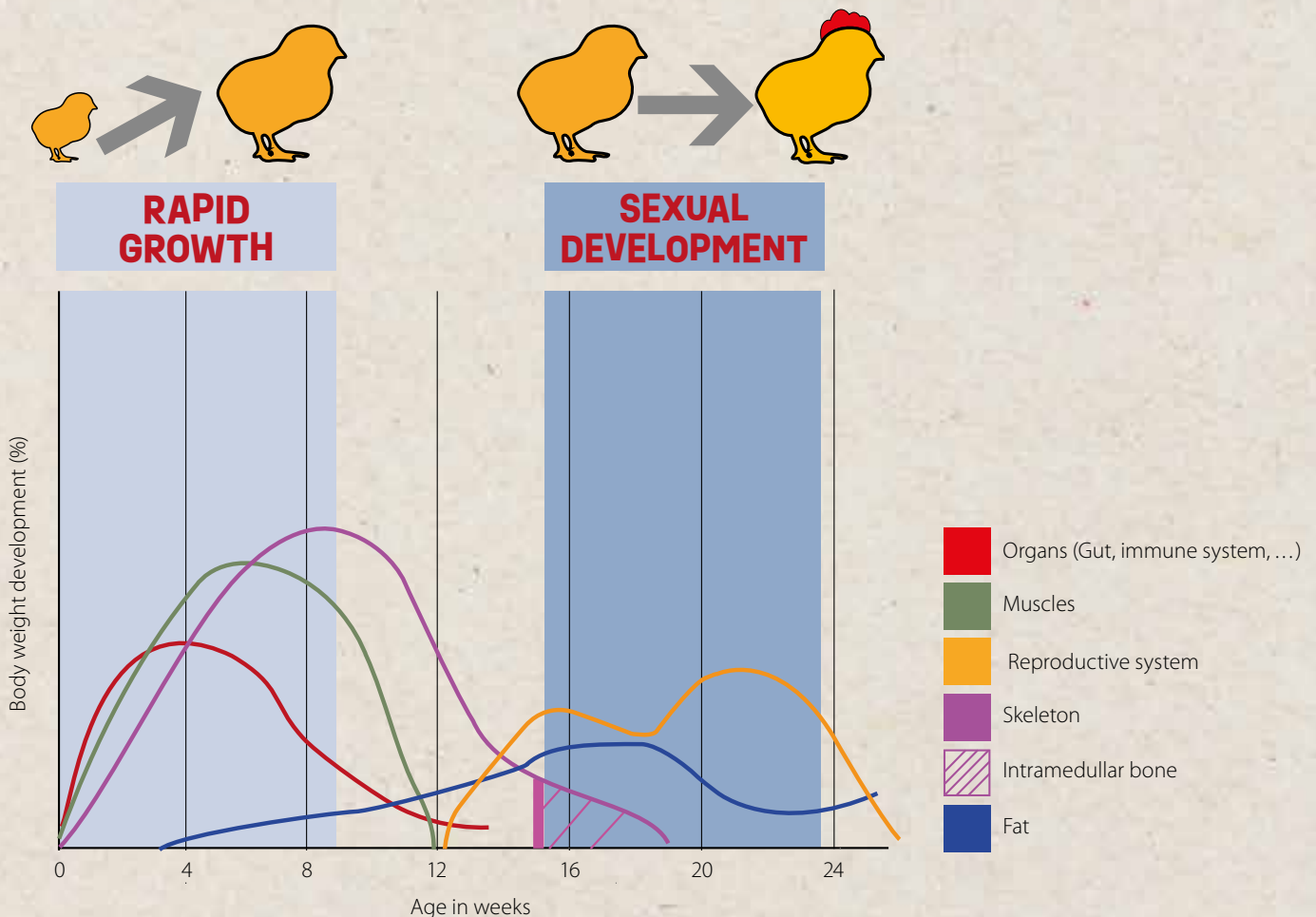

GROWING (3–9 weeks)

FEED INTAKE

Considering the importance of growth in this period, the daily consumption of the birds is below what it should be.

It is very important to promote good feed consumption to maintain correct development:

- Temperature at week 3 should be 22–23 °C. This can be slowly reduced over the next few weeks to around 19 at 9 weeks of age.

- Maintain a low stocking density. In aviary systems birds should be distributed along all the levels as soon as possible.
- Maintain the adequate feeder space.
- Start up from week 5–6 with training the chicks to empty the feeders once a day, BUT never restrict the feed intake.
- If the birds are ahead on body weight, advance the diet to the next one earlier, but don't restrict feed.

- Provide a “midnight snack” if the standard weight is not reached. In floor and aviary rearing keep an eye on your bird's behaviour during its implementation.
- Providing good quality feed is also key to good bird development.

Effect of the feeder space on body weight



Daily feed intake pattern

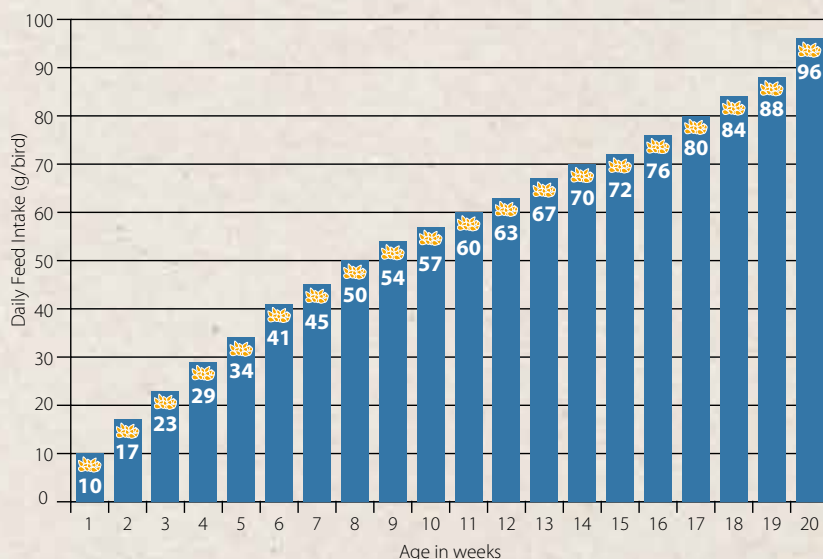

- Daily intake can vary depending on feed composition.

GROWING (3 – 9 weeks)

FEATHERING

Correct feathering is essential to enable a bird to regulate its temperature properly and is indicative of good development. A series of natural molting will occur during the rearing period. one complete molting (between 1 to 6 weeks) and three partials at 7 to 9 weeks, 12 to 16 weeks and 20 to 22

weeks when the stiff tail feathers are grown. It is important that molting occurs in the indicated periods, otherwise it may signal delayed physiological development of the birds: nutritional, management, disease or any other problem.

It is important to periodically evaluate the feather conditions both during rearing and production periods. Loss of feather during production could indicate a stressor, impacting on the flock.

Feathering and molting across the rearing period

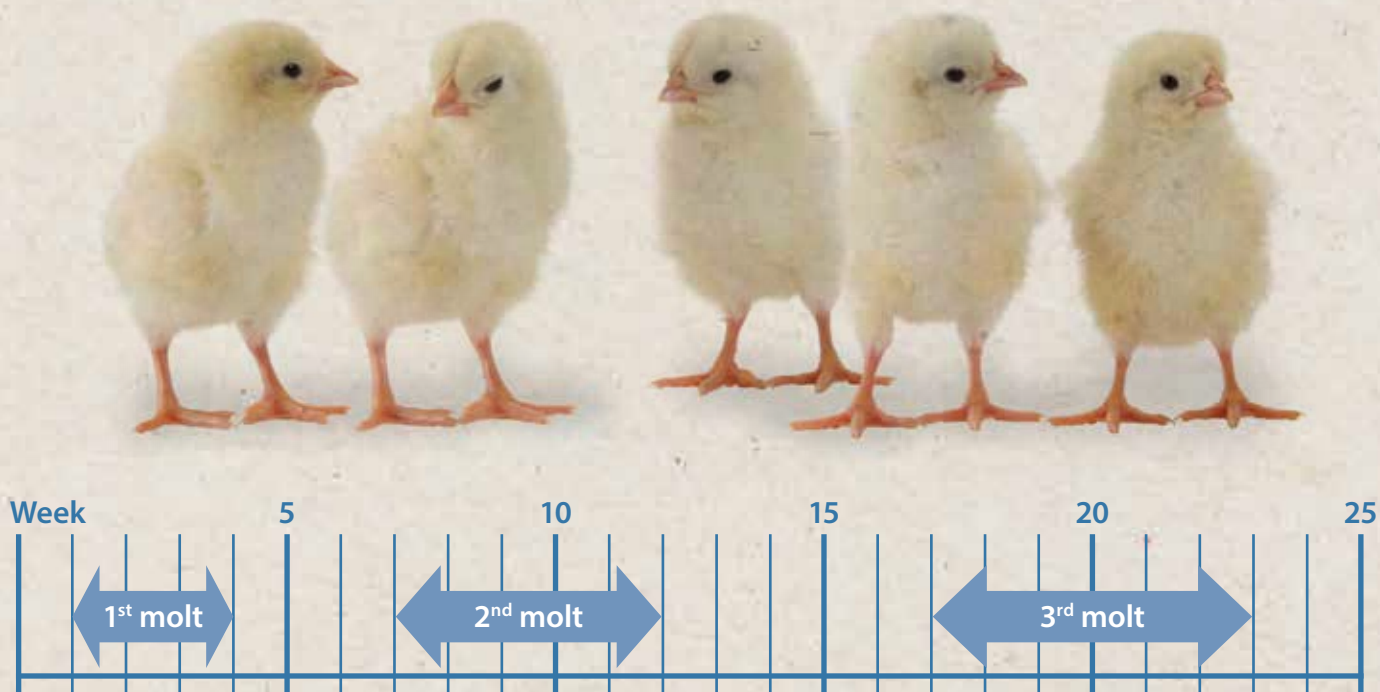

GROWING (3–9 weeks)

One of the tools to evaluate the status of the flock is by the primary feathers condition which can be done with certain frequency (for example, every other week). This can help us to either evaluate the status of feathering during rearing and production. Keep in mind that the number of molted feathers could give us an indication of the extent and magnitude of the stressor.

Here is a list of stressors that can impact on the flock inducing partial “molting” therefore impacting on the primary feathers development:

- decrease of daylight
- loss of body weight
- disease
- excessive cold or hot
- irregular feeding
- insufficient feed
- management (overcrowding, bad distribution true the system, water deprivation or low flow)

- insufficient feed or water space
- ventilation issue, etc.

Some birds reduce body weight and production but never cease producing eggs; you could see excessive feathers on the floor or manure belt.

Insoluble grit

Start to provide insoluble grit in a round feeder, or spread over the litter area ones a week. This to stimulate and development of the crop and gizzard.

Also improve the litter quality and keeps the birds busy.

Start to provide from 3–4 weeks till 10 weeks of age 3 g/bird/week with clean grit (2–3 mm).

Up to 10 weeks of age till end of rearing 4–5 g/bird/week (3–5 mm).

Provide some Alfalfa/Lucerne in floor/aviary rearing during crucial periods in rearing (1 bale 10 kg/2000 chicks).

Start to provide 1 week after the chicks have access to floor area and continue at least till 10–12 weeks of age.

When chicks take a lot of this Alfalfa/Lucerne, check the feed density and feed distribution!

After that slowly reduce the quantity to zero! Use pickstones in flocks without beak treatment.

When bird behaviour or feathering is not 100 % please continue with, this till end of rearing, and start also in production!

Keep litter level low during rearing period and try to keep the litter material dry.

This is will significantly reduce problems with high ammonia concentrations, and pullets who prefer to sleep in the litter area at night.



The axial and primary feathers on a wing of a chicken not in molt



Four feather molt, induced by an important stressor



One feather molt (First one); partial molting induced by a stressor.

Pictures from University of Kentucky: Evaluating Egg-Laying Hens

GROWING (3 – 9 weeks)

PERCHES

In most row aviary systems, and in height adjustable slats perches are already integrated. For other rearing systems perches are strongly recommended!

Perching improve nesting behaviour, animal welfare, improve liveability, bone/muscle structure and reduce floor eggs. They need to be placed as soon as 3 weeks of age.

Characteristics:

- Perches must have oval or round shape. If square perches are used in the layer house, they can used in the rearing facility.

- Perches should have minimum 5–7 cm of available space per bird. The value depends on the bird density (higher value for high stocking density).
- At least 2,5 cm width or wider.
- Is recommended to place the perches as early as 3 weeks of age.
- Perches helps to reduce piling behaviour.
- Perches improve bird welfare.
- Perches increase the effective floor space in the house.
- In case houses with 1/3 of floor with slats, always place the perches on the slats.
- Use the same type of perches in rearing and production.
- Preferably, place perches on the feeder line.
- Seal cracks, fissures and open ends of pipes to reduce areas where mites can hide.

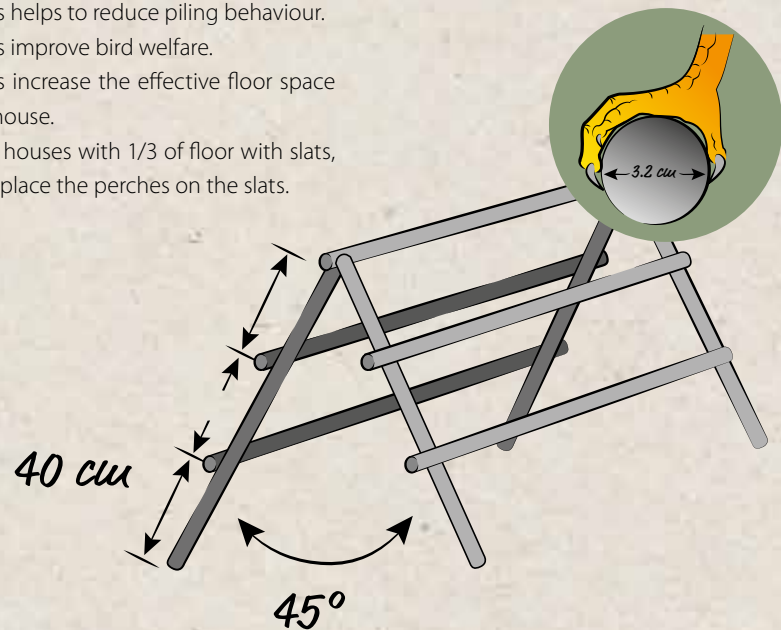

Key Points

- ▶ Implement the lighting program according to your global location and housing conditions.
- ▶ Never allow day length to increase during the rearing period.
- ▶ Give the chicks access to different levels, and litter area ASAP.
- ▶ Provide enough feeder / drinker space as soon as possible.
- ▶ Place perches at 3 weeks of age (floor rearing).
- ▶ Start with feed management, and feeding on a empty feeder from 5–6 weeks of age
- ▶ Achieve the required body weight at weeks 5 and 6 of age.
- ▶ Follow the feathering and natural molting timeline to monitor physiological development.
- ▶ Provide some alfalfa / pick stones/insoluble grit in rearing during this period.



REARING PERIOD (10 – 17 weeks)

- ▶ How to ensure weight gain and development during the last weeks of the rearing period.
- ▶ How to train the feed intake capacity to be ready for the production peak.
- ▶ How to prepare hens for the production period.

BODY WEIGHT

Weight gain slows during this period, but the chicks will continue to grow and develop. Most of the skeleton and muscular systems have already been formed by now and fat deposition will now begin to improve.

A correct fat level in the body is necessary to achieve the production peak, but overfat pullets will face many issues in production (prolapse and pecking late in production). The feed intake is higher than in previous weeks. The birds may be given a less dense feed.

If birds are within the weight standard or slightly above:

- Train feed intake capacity for the production peak challenge.
- Promote weight uniformity.

If birds are under the weight standard:

- Some compensatory weight can be gained by maintaining grower feed for several weeks. However, this is very limited, and the production period should be delayed.
- Maintain a low stocking density. In alternative systems birds should be distributed along the complete system on every level. We need to give ALL the birds access to all different levels.

Take these weekly body weights from birds on different levels, and in front and end of the house.

This is to be sure that body weight is increasing in uniformity in the flock!

When there is a difference in body weight you need to check the feed distribution.

Table 4: Pullet Body weight

Age (weeks)	Body Weight (g)	Diet
1	65	STARTER
2	120	
3	180	
4	250	
5	331	
6	418	GROWER
7	508	
8	597	
9	682	
10	763	DEVELOPER
11	841	
12	915	
13	986	
14	1055	
15	1122	
16	1190	
17	1260	HYBRID FEED
18	1329	
19	1393	
20	1448	

FEED INTAKE TRAINING

During the last weeks of the rearing period, the nutritional requirement is not very high. However, it will change dramatically in the first weeks of production. To help the hens deal with this challenge it is beneficial to train them to increase their feed intake during the end of the rearing period.

- **Low density feed.** From 10 to 15 weeks, it can be useful to switch to a feed (2700 Kcal, 15 % CP, 4.5 % fibre) that promotes feed intake.
- **Feed distribution program** allow hens to empty the feeders once during the day (see below diagram).

The feeding program should be similar to the one the layers will have in production. You can start this program as soon as 5–6 weeks of age (growing period) when chicks have access to all the living space in floor/aviary systems (see pictures of low level feeder on page 46).

Feed distribution in rearing from 5 till 17 weeks

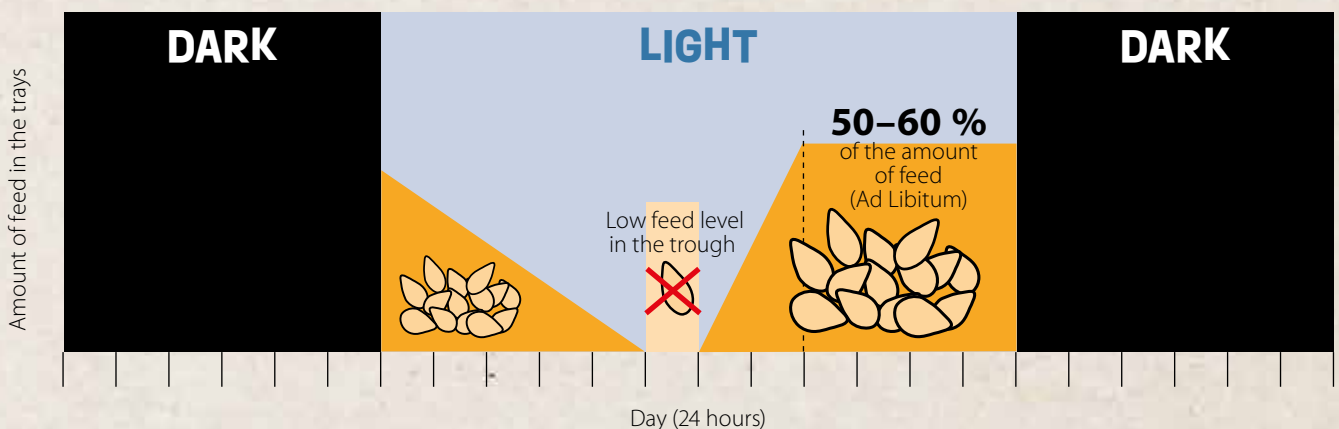

REARING PERIOD (10 – 17 weeks)

Body weights should be above standard, and uniformity above 85 %. **This is only possible if the hens are kept at the right stocking density and there is enough feeder space.**

To prepare the pullets to find the correct way in the production system, you need to be sure that they ALL move through the system in rearing.

Check before what kind of production system, and what kind of training you need to provide.

Train enough but be careful that you don't train to much!

When pullets go to a traditional barn system with slats, and nest boxes on slat level, or combi systems with feed/water/nesting on every level, you don't have to force all 100 % of the pullets to come out of the system in aviary systems, or of the slats in rearing!

When pullets transfer to aviary production systems where feed/water/nest boxes are on different levels each, you need to be sure that ALL pullets move through all the levels in rearing.



Gizzard with (left) or without (right) feed intake training

WATER TRAINING IN ROW SYSTEMS

- This water training is used to get ALL the pullets out of the levels with feed or water and jump to other levels.
- This to close the waterline on a level for a few days.
- This training is not without any risk and can cost some bodyweight and uniformity in a flock.
- **Discuss the need and kind of water training program with technical people from your chick and equipment supplier!**

MIDNIGHT LIGHTING

Midnight Snack

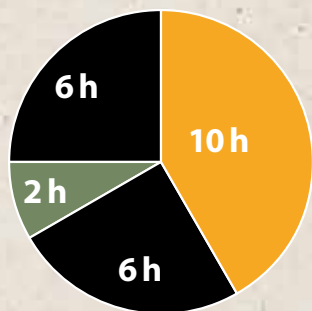

- Darkness
- Light
- Midnight snack

This management technique is used to increase feed intake and body weight during rearing period. It consists of lighting in the dark period to allow hens to feed and refill the crop.

The following guidelines should be followed for correct application:

- Switch on the lighting for at least one hour and up to two hours. These hours are in addition to the normal period of light.
- Midnight period must be at least (and never less than) three hours after switching off the lighting and at least three hours before the lights switch on.
- Feeders must be filled before the lights switch on.
- Water must be available

Midnight lighting can be used with different objectives:

- Increase in feed consumption. It can be used in rearing and/or production. It is especially useful in hot climates where birds are unable to feed properly in day time.
- This will help with the improvement of eggshell quality during production. The availability of extra calcium in the intestine allows better calcification and reduces bone decalcification (see midnight lighting program in production on page 76).



Please have an extra good look when you provide a midnight snack in floor / aviary systems concerning behaviour chicks/pullets.



Key Points



- ▶ Ensure body weight gain and correct development by maintaining feed consumption.
- ▶ Train hens to develop a good feed intake capacity by working with diluted feed and adapted feeding times where they empty the feeders once a day.
- ▶ Remove or separate small pullets from the flock.
- ▶ Maintain a low stocking density. In alternative systems birds should be distributed along the complete system on every level. We need to give ALL the birds access to complete feed by applying a good feeding management program.
- ▶ Train hens to move between the different levels in the system when needed for good behaviour in production system.

TRANSFER (16 – 17 weeks)

- ▶ How to prepare a flock for transfer to the laying house.
- ▶ How to transfer a flock correctly to the laying house.
- ▶ How to house a flock correctly in the laying house.

PREPARING THE PULLETS TO MOVE TO THE LAYING HOUSE

- It is recommended to transfer the birds between 16 and 17 weeks and once the vaccination program has been completed (after last killed vaccine). The birds should have time to become familiar with the new environment before they start to lay.
- If the feed and water systems used in the rearing and the laying house are similar it will help the birds make a smooth transition. The same light program as in the rearing house should be applied. As the page 27 shows, good communication and coordination between the rearing and the laying house is necessary to synchronize flock management.
- It is good management practice to visit the pullets several times during the rearing period.**
- Complete the vaccination program before transfer. When possible do not administer vaccines during the transport of catching processes.
- With start of catching the pullets early in the morning, give the flock 50 % of the ration feed the day before, and add water till the feeders are empty.

PRODUCTION HOUSE	
	<ul style="list-style-type: none"> All maintenance completed House clean and disinfected Feed in the silos Correct temperature Sampling of C&D process performed and satisfactory laboratory results received. Pre-heating in cold periods
FLOCK	
	<ul style="list-style-type: none"> Pullets on body weight Vaccine program administered Approved Sanitary certificate Flock information sent to production house (lighting program, feeding times, type of feed, body weight, etc.)
TRANSPORT	
	<ul style="list-style-type: none"> Transport truck ready Catching crew ready Housing crew ready Weather condition checked NO VACCINATION DURING CATCHING AND TRANSPORT!

- In hot climate period, or long distance transport plan with your technical adviser how to handle with feed and water the day before!
- There are aviary rearing row systems that give the options to lock the pullets inside the system an evening before transfer to make the catching easier.
- Use the same lighting program as run-in rearing, with the same dimming times at the end of the day.
- Try to complete the vaccination program early enough so the flock is not still reacting from the last vaccine.

STOCKING DENSITY IN THE LAYING HOUSE

The birds should have enough space, especially in hot climates!

When pullets are closed inside the aviary system, keep them only closed for a few days!!!! Important is not only 8-9 bird/m²/living space, but even more important that there is enough feed/water/nest box per bird in the house. (a minimal recommendation is given in table 5).

Overstocking has a strong impact on mortality, body weight and uniformity, feathering status and finally eggs laid per hen. In addition, local legislation should be respected.

Table 5: Stocking density at production house

Equipment	Requirements*
Stocking Density	475 – 750 cm ² /hen**
Drinkers	
Round drinkers	1 drinker (Ø 46 cm) for 125 hens
Linear drinkers	1 running meter for 80–100 hens
Nipple drinkers	1 nipple for 8–10 hens (access to 2 nipples/hen)
Feeders	
Round feeder	1 feeder (Ø 40 cm) for 25 hens
Chain feeder	10 – 15 cm / hen
Nest	
Family type nest boxes	120 hens / m ²
Family nest in family cages	50 cm ² /hen (42 to 65 cm ²)
Single nest (26 x 30 cm)	4 to 6 hens per nest

* These recommendations should be adjusted to meet local regulations.

** includes all the available space

TRANSFER (16 – 17 weeks)

TRANSPORT TO THE LAYING HOUSE

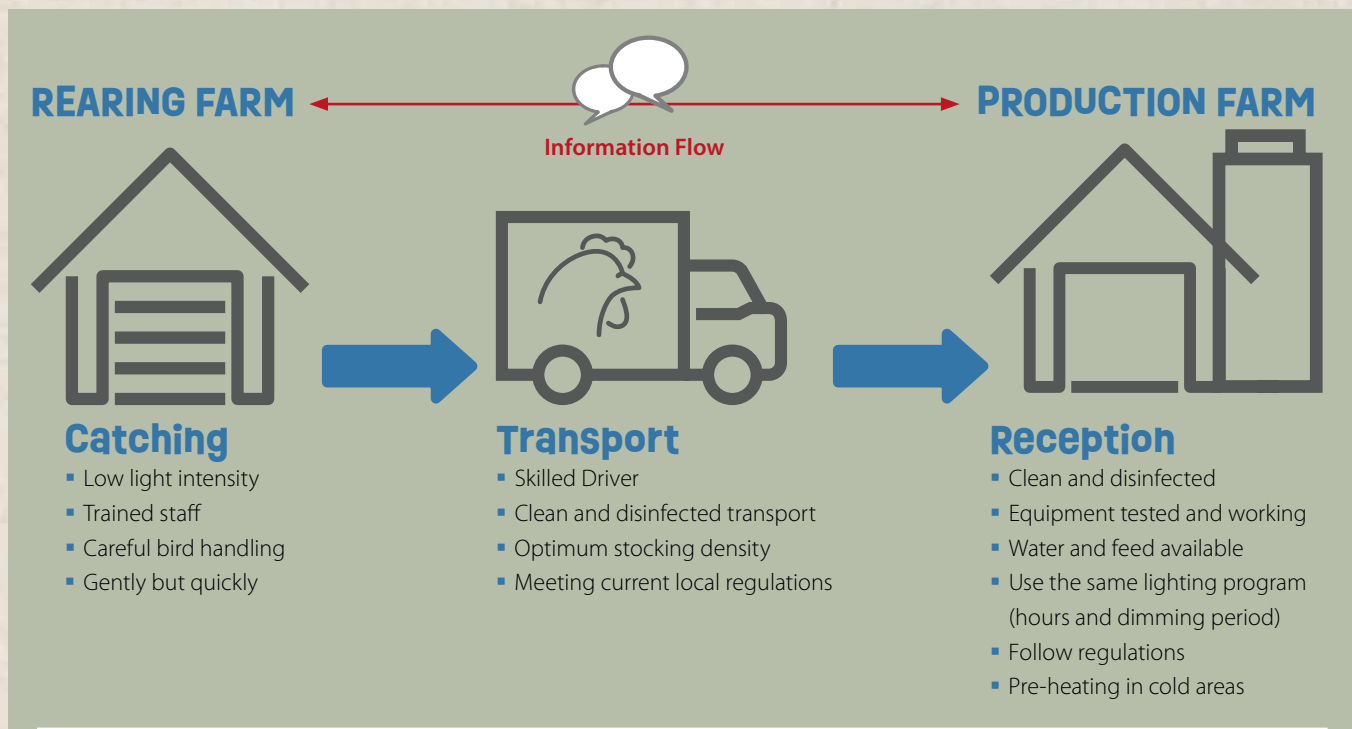

Preparation

Transport should be planned well in advanced and all staff involved should be informed. Transport equipment should be in good condition and thoroughly cleaned and disinfected. The staff in charge of handling and moving the birds should follow the biosecurity regulations, wear clean clothing and footwear that have not been exposed to poultry. Choose the best time of the day for transportation (especially in hot climates).

With start catching in the night or early morning, provide 50 % of daily feed the day before.

Provide water if feed is in the feeders (Keep water available ad-lib with transport in hot climate area's).

Keep an eye on behaviour of the flock during this period!

Loading

Load quickly but with care and maintain an adequate stocking density in the transport trolleys. Inform with your technical advisor from equipment supplier how to catch to pullets in the best and most efficient way! Continue to ventilate the house during the procedure. The staff should be well trained and should handle the birds according to

animal welfare regulations, catching and holding the birds by both shanks. Ensure enough ventilation for the birds between loading and unloading. Select out any defective birds, and any birds injured during the move.

Transport

Transport time should be as short as possible, avoiding unnecessary stops. Avoid moving the birds during the part of the day with more extreme temperatures, or when climate conditions could have a negative effect on the birds. Unload the trolleys or crates a.s.a.p. after arrival at the production house.

For very long-distance transport it is in some country's required to provide water during transport time.

In all Cases

- ▶ Do not catch hens by one wing or one leg or the neck.
- ▶ Do not overstock transport trolleys.
- ▶ Do not leave hens in trolleys in sunlight or unventilated areas.
- ▶ Do not load trolleys in closed and unventilated trailers.

Hens will lose some weight during the transport depending on the duration and the temperature. This loss will be quickly recovered if the housing conditions are correct.



When to move the Birds?

 **DURING MIDDAY**

 **DURING THE NIGHT OR EARLY MORNING**

TRANSFER (16 – 17 weeks)

HOUSING IN THE PRODUCTION HOUSE

Housing the Pullets

- Be sure that the housing plan is ready before start of it!
- Bring the right numbers of pullets in every different compartment of the production house.
- Place the pullets on the levels with feed/water in barn with aviary systems, and/or slats.

When the equipment gives the possibility to lock the pullets inside the system, or on the slats with doors or nets, do this only for a maximum of 3–4 days! This to help them find feed and water.

When you lock the pullets up for an extended period of time, the increased density will damage the uniformity of the flock.

Also, training the birds to move in the right way through the system is going to be more difficult when you lock them up too long.

Feed

Try to follow the same feeding program as used at the end of rearing and let them also empty the feeders once a day. Feeders should be filled when the pullets arrive, so it is easy for them to locate the feed. Also encourage the birds to eat by running the feeding lines more frequently

When pullets come from a pan feeder system in rearing, be aware that they could be scared when the feed chain is started to run and can jump out of the aviary system or slats!

If pullets are reluctant to eat after a couple of days, corrective measures should be taken at once.

Important is don't run feeders during the daily peak of production, to prevent hens moving out of the nests.

Temperature



The temperature in the laying house should be between 18 and 24 °C (Pre-heating). This is even more important in cage-free production, because of the lower stocking density kg/m³.

Place the pullets on the levels with feed and water in aviary systems, and not on the litter area and not in the litter area.

Feed



Place the pullets on the levels with feed/water. Use an "all-in all-out" system is recommended to break disease cycles and improve the health status. The production house should have been thoroughly cleaned and disinfected in advance. The transfer should be done as smoothly and quickly as possible to allow the birds to be well prepared for the start of laying. Cool water and feed must be available when the pullets arrive at the house.

When possible use the containers/crates also once a day, and/or clean in between.

In this way you prevent infection from rearing to production farm or vice versa!

Water



Advise to use open water cups or 360 nipple drinkers. The drinkers should be set at the correct height and pressure to encourage the birds to drink. Lower pressure for the first few days will help.

During the first days check frequently that the birds are drinking. Adapting to a new drinker system could be difficult (especially if pullets have been reared with a different kind of drinker). If water consumption does not increase in the days after housing, or it fails to reach normal levels, corrective measures should be taken at once.

Prepare the nipple drinkers with perches to prevent damage of them when birds are going to sleep on top in the night!

Nest Boxes



Keep nest boxes closed during housing the hens, when possible.

Hens need to use to nest boxes to produce eggs, and not to hide in the first days.

Advise to open the nest boxes 1–2 weeks before the onset of lay.

Note that in aviary systems with one-line nest boxes, the birds need more time to find them!

Open the nest boxes 3–4 hours before start of day/lighting program, and close about 1 hour before end of lighting program.

TRANSFER (16 – 17 weeks)

Light



Use the same lighting program as used in rearing, means same hours of daylength. When transport and housing of the pullets take more time during the daytime, give some additional hours light in the first day to give them the time to get used to the new environment.

The best way to do the dimming period at the end of the day(s) is manual.

Because of the new environment the birds need some extra time to find their way inside the aviary system, or on the slats.

Discuss this dimming program together with technical advisers from pullet and equipment supplier.

Look at behaviour of the pullets during this dimming period and switch off the light step by step.

Light intensity can be a little higher during the first week (20 lux) to encourage hens to explore the house and find water and feed. Avoid "light-shock (big step in light intensity between rearing and production) preventing stress and overstimulation.

Archieve a good light distribution to prevent shadow where bird can produce system/floor eggs.

Weight



Weight lost during transport should be recovered in the first days in the house. The birds should continue gaining body weight and maintain a good flock weight uniformity to achieve a good start of production.

Behaviour



Observe the behaviour of the hens during housing, and during dimming period at the end of the day. **Keep an eye on this the first days after housing!**

Litter



Appropriate litter level

Be sure that litter material is there in time the layers start using the litter area in barn/aviary houses.

Different materials may be used:

- Wood shavings
- Cellulose pellets
- Coarse wood shavings

Regardless of the litter material used, it should be hygienic!

A litter level depth of 1–2 cm is sufficient.

Litter material should preferably be distributed after the house is pre-heated, and when the layers have been housed.

This prevents the formation of condensed water between the floor and litter.

Keep the level of litter low and dry during whole production period!

Key Points

- ▶ Transfer the birds at least two weeks before the onset of lay to get used to the new environment
- ▶ Only transfer flocks that are healthy and in good condition.
- ▶ Plan transport in advance and organize it well to ensure optimal comfort for the birds.
- ▶ Avoid transferring flocks during high temperatures. Transport by night if necessary.
- ▶ Monitor the body weight before and after transfer to guarantee that the flock is developing correctly.
- ▶ Closely monitor water and feed consumption during the week after arrival at the laying house.
- ▶ In floor houses and aviaries, always check that the number of pullets per partition is the adequate.
- ▶ No vaccinations during transfer where possible.



ONSET OF PRODUCTION (18 – 25 weeks)

- ▶ How to manage the flock during the first weeks in the laying house.
- ▶ How to correctly apply light stimulation in line with flock status and production objectives.
- ▶ How to manage the flock to achieve a good production peak.

PERIOD AFTER TRANSFER

During the first days after housing, it is important to stimulate sufficient feed intake. The hens should increase their feed intake as fast as possible and continue gaining weight (see figure 1).

Some useful recommendations:

- Provide attractive feed with a good structure that avoids fine particles.
- Provide good quality, fresh water.
- Feed on an empty feeder.
- Light intensity should be higher in the laying house than in the rearing house.

- Avoid excessive stimulation when transferring birds to open houses.
- Run the feeding lines frequently during the second part of the day (not during production time in the morning). This to prevent that the hens come out of the nest. When bird had some other feeding system in rearing (Feeding pans) keep an eye on behaviour during running the feed chain because hens could be scared.
- Ensure there is enough light at the feeders/drinkers.

- Open the nest boxes 1–2 week before onset of production (first eggs) 4–5 hours before start of lighting program and close them 1 hour before start of the dimming period at the end of the lighting program.
- We want to have the hens inside the system, or on the slats at the end of the lighting program every day!
- Continue to give 3 gram/bird/month insoluble grit (4–6 mm) to stimulate the gizzard muscle and digestion of the layers.

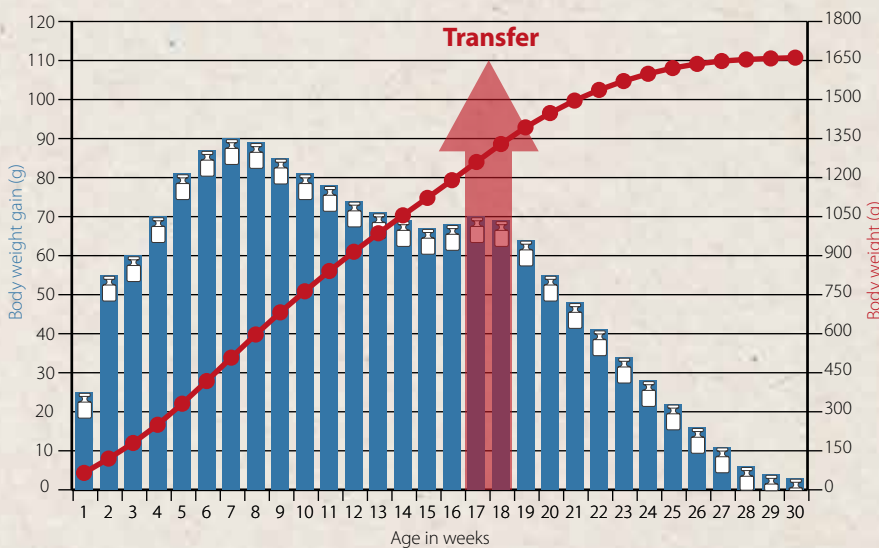

ACTIVITY MATERIAL

- Provide pick stones in the litter area (1 stone/1000 layers) to keep the layers busy and control the beaks.
- Provide Alfalfa (1 bale/1000 layers) in the litter to keep the layers busy, and to control the good and complete nutrition intake of the layers. When layers take this Alfalfa very

fast you need to check nutrition and feeding management to be sure that ALL the layers get the complete nutrition intake.

Check before that all the material you provide for the layers is clean (heat-treatment) to prevent pollution and diseases!



ONSET OF PRODUCTION (18 – 25 weeks)

LIGHT PROGRAM AND LIGHT INTENSITY

There are two main factors that stimulate the onset of laying in the flock:

- ▶ **Body weight**
- ▶ **Photoperiod**

In the absence of other stimuli, hens will begin to lay when they reach an appropriate body weight. However, the duration of the

photoperiod can stimulate or delay the onset of lay as follow:

- Stable or increasing photoperiods with a duration exceeding 14 hours will stimulate the onset of lay.
- Stable photoperiods with a duration of less than 14 hours will delay the onset of lay.

Decreasing photoperiods should never be used in production period.



Choose the right Stimulation Age

- ▶ **How to choose the right stimulation age**

Normally a flock should be kept with a stable photoperiod until light stimulation starts. If hens are in the weight range, a standard recommendation for standard production is 119 days of life.

However, this may vary according to two factors:

- Flock body weight status: If the birds' body weight is far below the standard it is preferable to delay light stimulation for at least one week. Equally, if the CV is very high and the weight of part of the flock is far behind the standard, later light stimulation is preferable.
- Accumulated egg weight objective: egg size strongly correlates with the size of the bird. A simple way to get heavier birds in the production onset is to delay light stimulation. Age at 50 % lay and body weight at 50 % lay are two values that can greatly help to forecast the egg weight.



Take the natural Day Length into account

- ▶ **How to deal with natural day length**

The light program in open houses should take the natural day length at the stimulation age into account. Determine the light program during rearing as explained in chapter growing (page 27).

Stimulation should differ depending on the day length.

- The light program in open houses, free-range and organic should take the natural day length at the stimulation age into account.
- Increasing day length period: flocks' risk being stimulated by natural light before they reach the correct body weight. To avoid this, the artificial day length should always be longer than the natural day length until the flock is ready to be stimulated. This should be considered in the rearing light program.
- Decreasing day length period: flocks exposed to decreasing day length can show delayed onset of lay. To avoid this, create an artificial day length longer than the natural day length from week 10.

To achieve this goal, use the app: H&N lighting program



Use correct Light Stimulation

- ▶ **How to apply light stimulation in a flock**

Once the light stimulation age is defined, light stimulation starts with an initial photoperiod increase. Take the following into account:

- Light distribution should avoid dark and shady areas, to prevent floor/system eggs.
- Start to increase day length at least one hour after sunset, or after switching off the light at the end of the day and keep the last hours to increase on the start of the day!
- Keep an eye that first eggs not produced before start of lighting program and causes floor / system eggs.
- Increase the day length at least one hour.
- Light intensity in the laying house should be slightly higher than in the rearing house.
- Keep light sources clear.

Subsequently, the photoperiod must be increased weekly. Light increases should be at least half an hour, although a higher increase is possible if the laying percentage increases rapidly. The more hours the hens have, the more time they will use to consume feed. It is therefore important to achieve at least 14 hours of light to allow the flock to reach a proper feed intake.

ONSET OF PRODUCTION (18 – 25 weeks)

SEXUAL MATURATION AND ONSET OF LAY

At the start of their productive life, hens develop their secondary sexual characteristics. This is a good indication that the bird's hormone development is correct. In addition to the start of the reproductive capacity (and therefore production of eggs) other changes occur in the bird's metabolism.

One of the most important is the ability to capture calcium to create intramedullary bone. It is very important that the birds develop this type of bone to ensure good quality eggshells during the late lay period. Good practice is to **use a transition feed** as explains in the nutrition chapter.



Closed house decreasing days

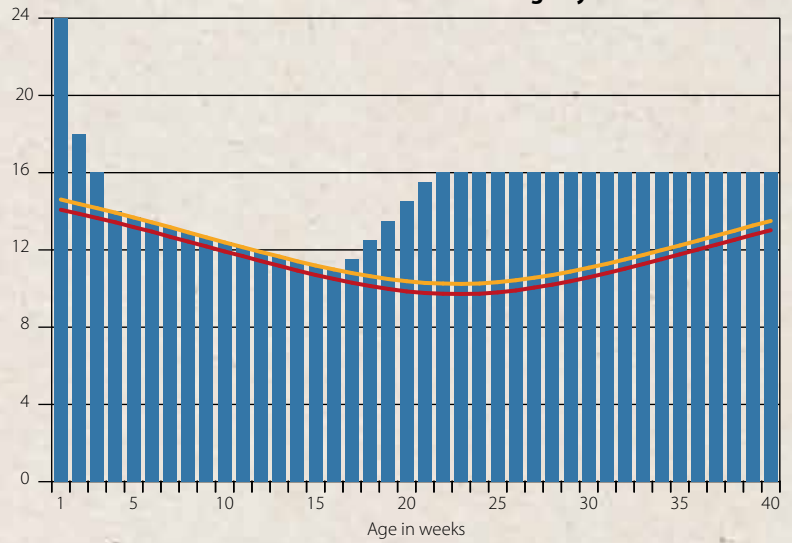

Open house increasing days

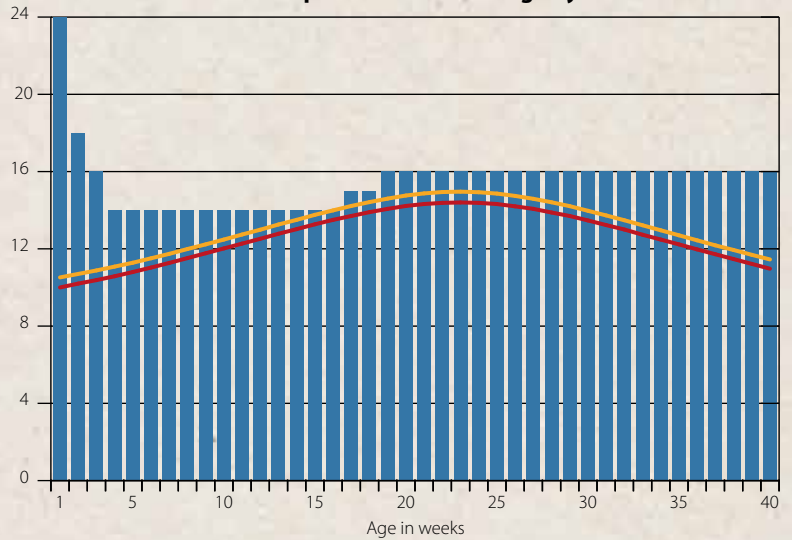

Open house decreasing days

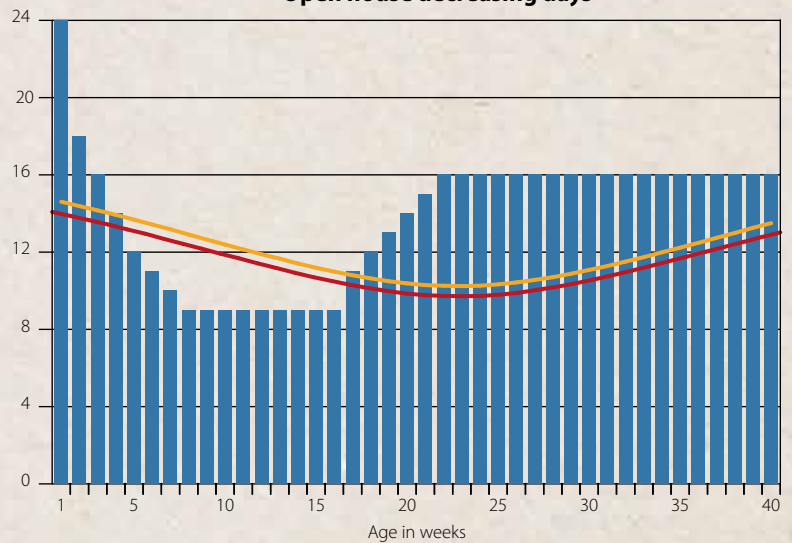

■ Lighting program
 ■ Twilight
 ■ Daylight

ONSET OF PRODUCTION (18 – 25 weeks)

MANAGEMENT TO THE PRODUCTION PEAK

Water

Cool water of good quality should always be available with the required water flow. Continuously monitor the water quality. Water consumption is normally 1.5–2 times higher than feed consumption. It is highly recommended to monitor the water consumption for early detection of possible problems. Regular cleaning and flushing of the water lines as well as the supply tank is essential. Water consumption will clearly increase at 10–14 days prior to the onset of lay. During this period, the ovary and reproductive organs and medullary bone will develop, and water will be stored in the follicles of the ovary.

- On aviary system where water and feed are not on the same level, keep an extra eye on hens that do not move in the correct way into the system!
- Take some hens on the different levels a few times a week and check the condition.
- Often you feel that some hens are weak, or crops are only filled with either feed or water.
- There are some water training programs to stimulate the hens to move to other levels for feed/water. With these programs you close feed/water on different levels. Beware that these programs can give big problems with condition and uniformity of the flock when wrongly use!
- **Keep in contact and discuss always with supplier from pullets and equipment before using these programs!**
- Keep in mind that a good, trained pullet should find the way in the aviary system.
- With hens who go outside the house (free-range/organic) prevent too high water intake from rainwater in the outside area!

Space

The birds should have enough space, especially in hot climates. Important aspects are not **only cm² living space/bird**, but also how many cm of feeder, and how many drinkers are available per bird (a minimal recommendation is given in page 36).

Feed

The birds need a good quality feed, with the structure and nutrient density necessary to suit their feed intake as well as provide their egg production, growing and maintenance requirements.

Nutrient requirements in this phase increase rapidly so the feed intake of the birds should increase simultaneously. If not, then the birds' nutrient requirement will not be met, and they will be forced to mobilize their reserves. This may lead to soft bones and potentially harm the bird for the rest of the laying cycle. Switching to a layer diet with more than 2.5 % calcium stimulates the birds to lay eggs. This feed phase I aims to cover the requirements to obtain the maximum egg mass (see nutrition chapter for further details of feed recommendations). Keep on feeding on empty feeders as trained in rearing period. Prevent select feed intake (see Technical Tip "Feeding management").

Mash Feed



Crumble Feed



Pellet Feed



Ventilation & Temperature

Proper ventilation should be used to guarantee good air quality in the house and ensure a low concentration of gases and dust. At the same time the temperature in the house should be optimally maintained between 18–24 °C (64.4–77.0 °F) with a relative humidity of 50–60 %. Birds do not tolerate temperatures above 30 °C (86.0 °F) well, especially if high temperatures are combined with high humidity. During heat stress, ensure that sufficient air circulates around the birds. The use of additional fans as well as evaporative coolers should be considered to reduce the house temperature.

In aviary and floor production, ventilation and temperature is even more important to start with a good house temperature before transferring the pullets.

The stocking density is less than cage systems, and we need good temperature and ventilation to stimulate pullets to find water and feed on the different levels in the system (important in aviaries).

Mortalities smothering and floor/system eggs can be enhanced by poor ventilation.



Good air quality: you can see the back of the house

ONSET OF PRODUCTION (18 – 25 weeks)

NEST MANAGEMENT

Key points of using nest boxes in cage-free systems:

- Right position of the nest boxes with drinking lines in front of them
- Use clean, automatic closing nest boxes with comfortable floor/mat.
- Nest boxes with the correct intensity of light (enough to find the nest, and inside dark enough to keep birds quiet).
- Enough nest space.
- Layers should not be allowed to have access to the nests too early. Open the nest boxes 1–2 weeks before the onset of lay. Open them 4–5 hours before start of day-lighting program and close 1 hour before the end of the lighting program (NEVER leave them open overnight).
- In an aviary system with one tier/level of nest boxes the birds need some more time to find the nests than a traditional floor house with slats or combi system where you have nest boxes on every level.
- System with on-line nest boxes can be equipped with incorporate barriers. Best way to use them every 2 meters at 6 meters from every compartment wall. This to prevent high density in these front and back nests.
- In case, of early production eggs you can also use very low light intensity lights inside the nests. This light can start 1–2 hours before the start of lighting program to give the birds that produce early to find the way to the nest boxes. These 1–2 hours are not included in the daylength.
- Always try to use more than standard nest space in cage-free systems to catch all the birds/eggs during the laying process. Especially at the onset of production of very uniform flocks.
- After the production peak at > 30 weeks, we can start gradually closing the nest boxes a bit earlier every 1–2 weeks. In the afternoon, the birds don't need access to the nest boxes after the production period (10 hours after lights on) This is especially important if you start to see a lot of dirty nests (bedding or mat) and eggs due to nest material.
- Close the nest in very small steps, and keep an eye on total number of eggs, and number of floor/system eggs. When these numbers stay same level, you can make the next step.
- For a correct nest management, always keep in mind the difference in the laying behaviour between white and brown strains:
 - a) Browns tend to start the production earlier than whites, so the egg collection must start earlier.
 - b) In white flocks, at peak production hour a higher % of females are laying, plus the hens stay longer inside the nest than browns, therefore nest space is more critical for the white layers than brown layers (refer to graph page 49).

Type of nest	Requirements*
Family type nest boxes	100 hens / m ²
Single nest (26 x 30 cm)	4 to 6 hens per nest

*These recommendations should be adjusted to meet local regulations.



Overcrowding nest

Practical advise

- ▶ Start the day with a distribution of feed.
- ▶ Stop feed distribution completely during the following hours of the day.
- ▶ Restart feed distribution when the feed troughs are empty. This usually takes about 5–7 hours but may vary between flocks. This should be determined by visiting the house and observing the levels in the feeders on each level of the system.
- ▶ It is not necessary to keep the feeders empty once the birds have eaten their entire ration. In aviaries, if one of the feeder lines is empty, distribution can be restarted. If the difference in feed level is too great between lines, their adjustment and the distribution of the birds should be reviewed.
- ▶ Restart the feed distribution by two consecutive feed distributions. The aim is to ensure that all birds have feed available.
- ▶ After this, continue to distribute feed throughout the afternoon and until lights out. The number of feedings may vary but, in any case,, ensure that the birds have feed at will.



ONSET OF PRODUCTION (18 – 25 weeks)

ONSET OF LAY

Monitoring production data is essential for timely intervention in response to any issues that occur in the weeks between the first eggs and the production peak. Production data should be monitored daily or at least weekly.

Check regular when first eggs are produced to be sure that day length cover the production period!

% Lay

This should increase daily. During the first week, the increase may be small, but a bigger increase should be seen every day afterwards. In the middle part of onset of lay, the increase should be stronger: at least 2 % per day and ideally close to 3 %. Finally, in the last weeks, the increase should be close to 1 % until the production peak is reached. The rate of increase cannot be monitored correctly if the eggs are collected at different times.

Body Weight

increases could be a little erratic as not all the hens develop their reproductive system at the same time. However, body weight should never decrease, and a clear growth trend should be observed.

Check body weight of layers all over the house, in front and back, and at all levels to be sure that feed distribution is running consistently throughout the house.

Feed & Water

As mentioned, consumption should increase every day.

Water is the easiest parameter to monitor daily and is a critical management measure.

Body weight and % lay until week 30

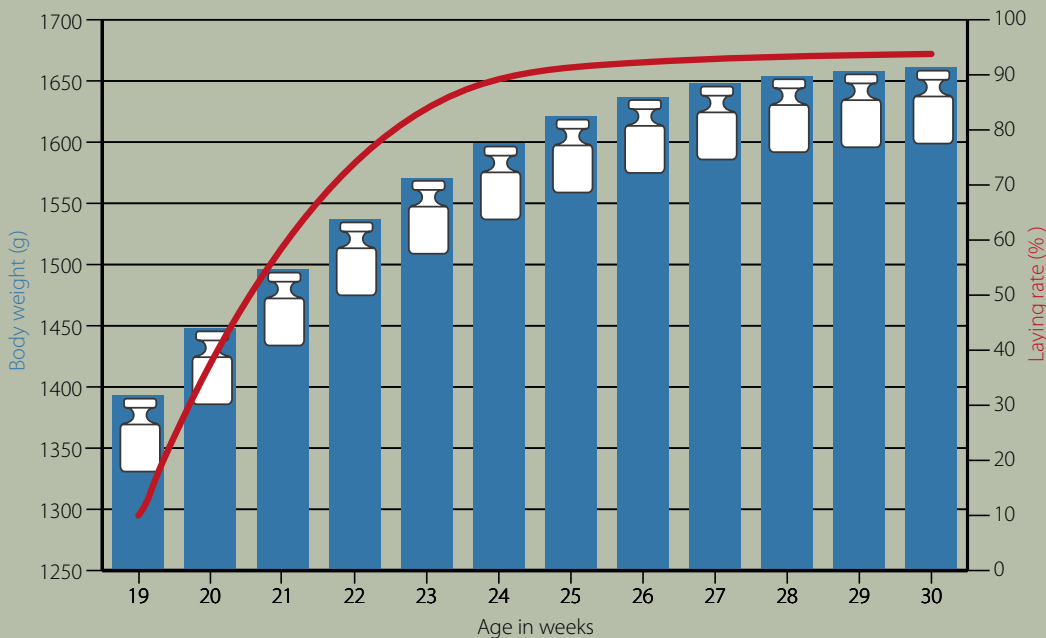

ONSET OF PRODUCTION (18 – 25 weeks)

STRESS MONITORING IN LAYERS

A simple and effective way to monitor the stress level of the birds is the use of alfalfa. The hens do not use it for feed but for entertainment and to see if the birds are on balance concerning nutrition intake. If the consumption of alfalfa is observed to increase dramatically, this should be taken as a clear message that the flock is being exposed to some form of stress. This gives precious time to check which factor is affecting the birds and to apply corrective measures before severe pecking episodes occur.



Alfalfa net



Alfalfa rack

FEEDING LAYERS DURING PRODUCTION

Hens have a strong feed selection behaviour based on particle size. Coarse feed particles will be much more attractive than fine feed particles to the hens and they will actively seek them out. In cage-free systems, each hen has access to many feeding points where she can feed only on the coarse fraction of the feed. If this behaviour is allowed, the birds will eventually reject the fine fraction of the feed. This will greatly complicate the feeding of the birds and can be the starting point for many potential issues.

To avoid this problem, it is an absolute must to force the birds to eat the entire feed ration



Normal level



Low level

daily. The simplest way to do this is to force them to empty their feeders. To do this, feed distributions should be stopped during the morning. During the afternoon the birds should be fed ad libitum. In no case should

this management imply that birds are subjected to feed restriction.

Feed distribution in production

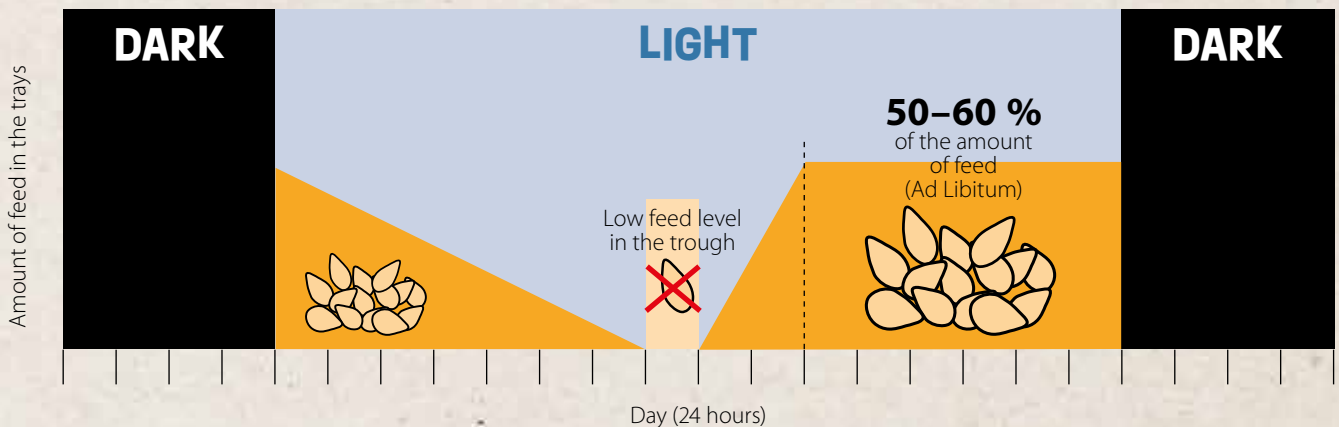

ONSET OF PRODUCTION (18 – 25 weeks)

FLOOR & SYSTEM EGGS

The correct use of nests is very sensitive in order to keep the percentage of floor eggs at a manageable level. Birds tend to lay their eggs in the same place every day and are attracted to dark, enclosed places as well as to the presence of eggs laid by other hens. It is therefore critical to manage the flock correctly and to avoid the hens getting used to laying in places other than the nest.

A correct stocking density is a precondition for a good use of nest boxes. If the stocking densities are not respected, the nests will be overcrowded and some of the hens will be forced to look for alternative laying sites. Keep in mind that white birds have a greater need for nest space as they tend to all lay in the same time slot.

It is important that the hens regard the nest as a nice place to lay. It should be dark, secluded and free of drafts. The temperature

inside should be warm but not too high. Likewise, the material of the nest floor and its design is essential both to give comfort to the hen and to prevent the eggs from being soiled, broken or pecked.

Finally, any obstacles that prevent the birds from easily entering the nest should be removed.

There should be no other attractive spots in the house for the hens to lay. First of all, it is important to check that the litter is no more than 1–2 cm thick to avoid nesting in the litter. Less well-lit areas should also be avoided, especially corner and wall areas. When allowed it is also a good idea to divide the house into horizontal segments by wire fences. This will prevent hen migrations from creating overcrowded areas.

The birds must have been trained during rearing to move to sleep in the slat area or in the aviary. In any case, during the first weeks in the production house, this should be checked and hens which are sleeping on the litter should be moved manually to the slat area. It is also very important to collect the eggs laid in the litter daily and under no circumstances to leave eggs in the house after the lights have been switched off. The areas of the house where hens lay eggs most intensively should be identified for specific measures to be taken.

It is also advisable to take frequent walks around the house in the morning to prevent hens from nesting in corners or against walls. Likewise, feed should not be distributed during peak laying hours (mainly mornings) so as not to attract hens out of the nesting area.



Floor Eggs



Floor/System Eggs



Floor/System Eggs

Key Points

- ▶ Monitor how well the flock has adapted to the laying house by measuring water and feed consumption daily and body weight weekly.
- ▶ Control the onset of lay and egg weight by correctly applying light stimulation.
- ▶ Never decrease day length in the production period.
- ▶ Closely monitor the increase in egg production, egg weight, body weight, feed and water consumption during the weeks preceding the production peak. If the flock is not performing correctly, take corrective measures as soon as possible.



PRODUCTION PERIOD (25 – 100 weeks)

- ▶ How to manage the flock to maintain optimal production levels during the production period.
- ▶ How to maintain hens in good condition regarding body weight and feather covering.
- ▶ How to correctly manage the produced eggs.

PRODUCTION STAGE

After reaching a good production peak, H&N hens should enter a production plateau. Their genetic potential allows them to maintain a high production level and good eggshell quality for some weeks but to achieve this, pay close attention to certain aspects:

- Feed quality
- Daily intake
- Absence of diseases
- Body weight

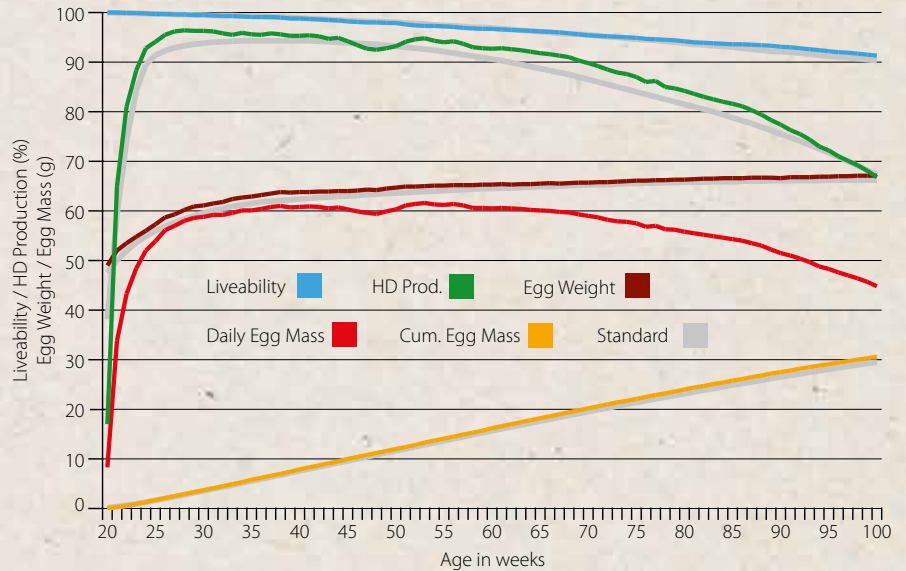

	Weeks > 90 %	Eggs/HH	Liveability	Cum. EW (g)	Cum. EM (kg)
Standard	51	490.8	93.5	63.9	31.3
	37	467.7	90.3	63.1	29.5

PRODUCTION MONITORING

Detailed laying cycle records are necessary to evaluate performance and profitability. Daily figures for hen-day production, egg weight, feed and water consumption, floor eggs and mortality are necessary. This information will allow you to calculate very

important data including daily egg mass, cumulative egg mass and feed conversion. All results should be presented in graphs. Use of graphs will improve analyses of flock performance trends. Growth records, accurate counts are also very important.

This enables timely intervention in response to any irregularities and generates historical data for more in-depth analysis of production performance.

Number of hens housed (A)

PRODUCTION RECORDING SHEET

Date	Flock			Production week				Production cum.				Egg weight				Egg Mass/HH				Feed Intake		Feed conversion			
	Age	Mortality (No.)	Hens remaining	% Livability cum.	Eggs produced	% Production	% Standard	Floor eggs	% Floor eggs	Cum. Egg production	Eggs/HH	Standard	Cum floor eggs	In the week	Standard	Cumulative	Standard	In the week	Standard	Cumulative	Standard	In the week	Grams /bird /day	kg /feed /HH	In the week
	B	C	D	E	F		G	H	I	J		K	L		M		N		O		P	Q	R	S	T
		C (A) - B	C / A *100		E/C/7 *100			G/E *100	I+E	I/A		K+G			L/H		E*/L/A		O+N				R+P	P/E /L * 1000	R/I /M * 1000

PRODUCTION PERIOD (25 – 100 weeks)

LAYING PROCESS

Laying Process

Egg formation is a complex process that occurs in the oviduct of the hen. The whole process takes around 24 hours, but forming the eggshell takes most of the time (18–21 hours).

Lay is a critical moment for hens. If possible, they prefer a protected and dark area. The cloaca could be reversed during the lay process which can encourage cannibalism.

If hens retain eggs due to stress, shell defects may occur. Therefore, avoid disturbing hens during maximum laying hours to reduce this kind of defect. This means not disturbing them by removing dead birds, feed distribution, inspecting nest boxes ...

Laying Window

The laying window is defined as the time in hours since the lay of the first egg to the last

one. Its range varies between breeds of hens. White breeds lay in a shorter period of the day than brown breeds. Additionally, white hens spend more time in the nest box. This is the reason for the need of more nest space for white hens.

Any case, 50 % of the lay takes place around 4–6 hours after switching on lighting or after the sunset. It is useful to know when most of the eggs have been laid for a better collection.

Lay distribution during the day

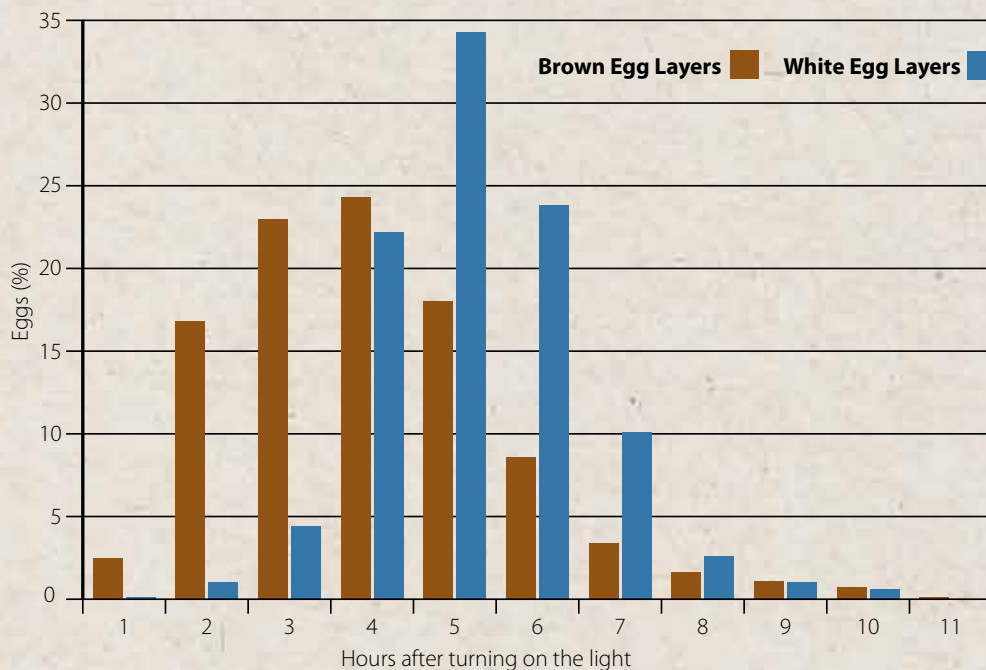

EGG COLLECTION

Egg collection impacts the external and internal quality of the produced eggs. It must therefore be performed correctly in order not to degrade the value of the eggs:

- Collect eggs as soon as possible. Do not keep eggs in the house but collect them and store them in a cool (max. 18 °C) and dry place.
- Collect the eggs twice a day, especially in hot climate periods.
- Avoid overstocked nests or egg belts. This may increase the number of cracked and soiled eggs.
- Prevent hens from eating or pecking the eggs.



PRODUCTION PERIOD (25 – 100 weeks)

NEST MANAGEMENT

Nest boxes should be kept closed at night to prevent hens from sleeping inside them. This would cause the floor material to become soiled with feces and increase the percent of dirty eggs.

Therefore, the nest boxes should be opened at least 4–5 hours before lights on and closed one hour before lights off. After peak production and stabilization of the percent of floor eggs, nest closure can

be brought forward in small steps every week. This should always be done while checking that the percent of floor eggs does not increase.

FEATHER COVERING

Feather coverage is a key indicator of the hen's body condition. If hens lose their feathers, their thermal insulation capacity will remain seriously impaired. This impacts directly on feed intake and maintenance energy needs. It therefore means an increase in the production feed costs. Poor feathering can also be caused by stress, pecking or incorrect feeding.

Monitoring feathering can help signal potential problems caused by aggression, nutritional deficiencies or other problems.

Feathering Condition Scoring

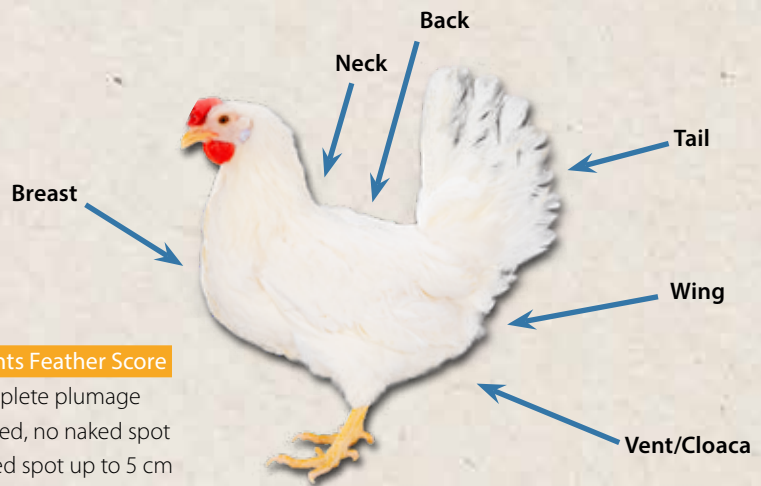

4-points Feather Score

1. Complete plumage
2. Ruffled, no naked spot
3. Naked spot up to 5 cm
4. Naked spot greater than 5 cm

FEATHER PECKING

Feather pecking can be considered in hens as part of hen social interaction if it is kept at a low level. However, if birds are subjected to stress or are unable to express their behaviour, feather pecking can become exacerbated and develop into aggression and even cannibalism.

Beak treatment has been proven to be effective in preventing feather pecking. However, it is not permitted in some countries.

In any case, it is necessary to control the sources of stress affecting the birds. Not all sources of stress are equally disturbing to birds but they all work in an additive way.

The following points should be avoided:

Most common Causes of Stress

- Sudden increases in light intensity.
- High light intensity (> 50 lux)
- Direct sunlight entering into the house.
- Nutrient-deficient feed formulations
- High or low salt levels in the feed.
- Birds not being required to empty feeder daily
- High density due to over housing of birds or to poor distribution of birds in the house.
- Birds housed in a system for which they were not trained in rearing.

Other possible Causes of Stress

- Bulbs with inappropriate light color and producing flickering effect.
- Lack of partitioning in the house
- Litter in poor condition or dusty substrate.
- Very poor environment: Lack of sufficient perches, non-use of pecking stones, non-use of alfalfa.
- Heat stress during warm season
- External or internal parasite infestation
- Predation episodes

PRODUCTION PERIOD (25 – 100 weeks)

KEEL BONE FRACTURES

Hens often suffer collisions against equipment when moving around the interior of house. This can lead to keel bone fracture if this bone is hit and it is weak and brittle.

As result, it will cause injuries in the birds that produce chronic pain, refusal to move, immunosuppression and reduced egg production. Unfortunately, this is reported to happen in a high percentage of cage-free flocks.

Some risk factors for collisions have been identified, such as

- the absence of ramps between floors,
- the height and placement of perches and
- the type of aviary.

However, hens are clumsy birds and a number of them are likely to collide whatever the aviary.

Bone integrity and strength therefore seem to play a key role. Calcium physiology is always understood as a challenge in birds with a high production capacity. Therefore, a good rearing period and specifically good ossification before first egg production seems to be key to create a strong bone system and avoid keel bone fractures. Likewise, calcium management in the

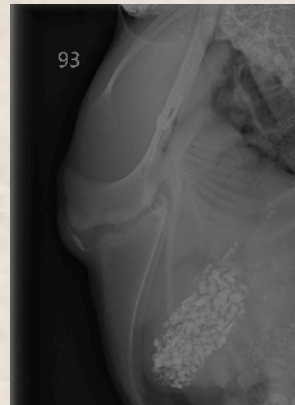

Keel bone fracture – courtesy of ZTHZ, Universität Bern

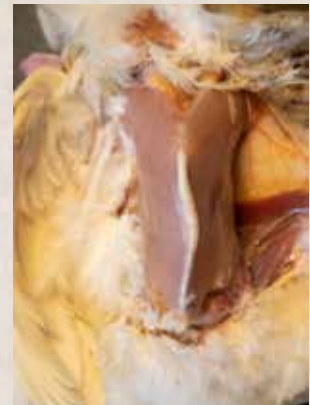

Keel bone Rx

feed and the occurrence of metabolic diseases as osteoporosis or osteomalacia should have a clear impact on this problem.

PILING

Piling is a behaviour of birds whereby individuals are crowded together in high densities in a certain place. One of the most common consequences is mortality by smothering. It can be the leading cause of mortality in some flocks. The cause of this behaviour is sometimes not easy to identify, but it is possible to distinguish at least three types of origins:

Nest Piling

This refers to piling where the origin of the crowding is the use of the nest by more hens than the maximum capacity. In fact hens may prefer some nests to others and crowd into them. This can also happen with the use

of perches at the top of the aviary. They are easily identifiable as the smothered birds always appear in the nests or in the same particular location.

Panic Piling

This refers to those whose origin is one-off event that causes an episode of panic in the birds. Usually the number of smothered birds is high and can be found in corners or against walls. Sometimes they are easy to identify when this event is very evident (predation episode, loud sounds, disturbing visits, ...). At other times the initial panic event is more diffuse. This is especially true when the flock is previously under stress. In this case

subtle events will be sufficient to trigger an episode.

Reiterative Piling

This refers to piling occurring the same place repeatedly throughout the laying period and do not usually involve a large It is not easy to find the reason for this but temperature in different parts of the house, condition of the litter, draft in certain sections of the house or incoming sunlight have been blamed in some cases. As with the previous group, if the birds are under stress, they are more likely to occur.

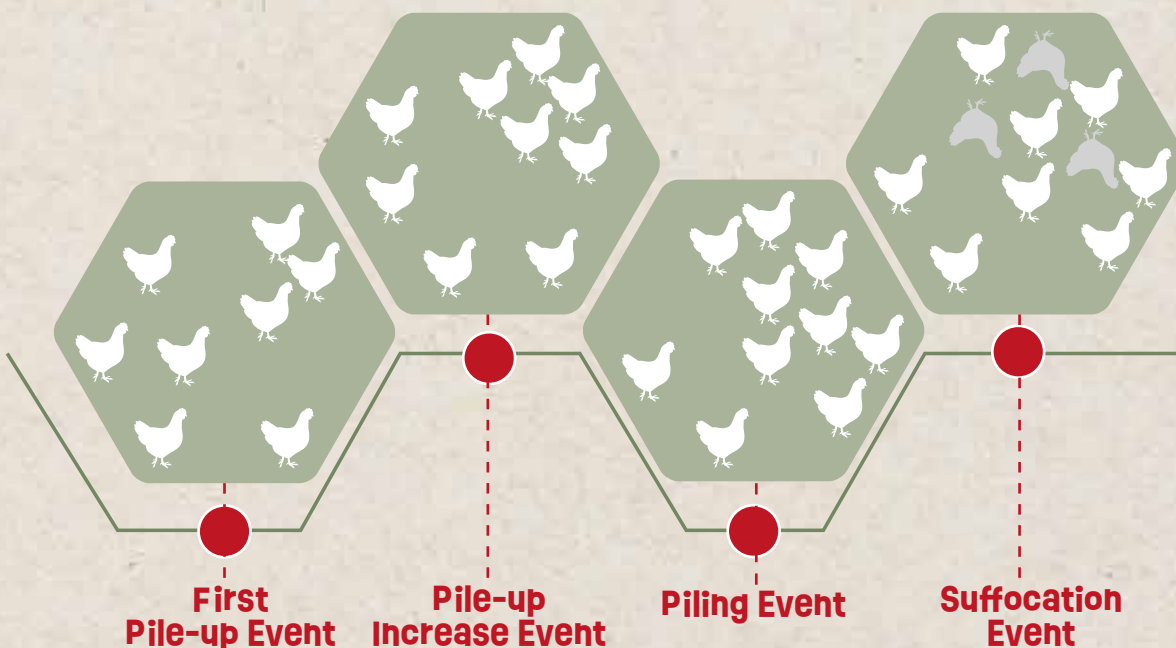

PRODUCTION PERIOD (25 – 100 weeks)

TROUBLE SHOOTING

Problem	Possible cause
Lay drop	Low feed intake, low water intake, stress factors, feed quality, decreasing light program, pathology, incorrect feed distribution
Low feed consumption	Temperature, water supply, feed quality, inadequate feeder space, incorrect feed supply, pathology, incorrect feed distribution
Low egg weight	Temperature, low feed consumption, low body weight at light stimulation, incorrect feed formulation
Mortality	Flock uniformity, light intensity, stress factors, pathology, pecking cannibalism, smothering, predation
Low body weight	Incorrect feed formulation, low feed intake, high stocking density, incorrect feed distribution
High body weight	Incorrect feed formulation, overfeeding
Cracked eggs	Ca/P ratio, Ca particle size, temperature, water quality, pathology, incorrect egg collection management, incorrect feed formulation, incorrect grading machine maintenance, floor eggs
Stained eggs	Water quality, pathology, incorrect egg collection management, incorrect feed formulation, incorrect grading machine maintenance, high stocking density, pest / diseases, floor eggs, dirty nest
Floor eggs	Incorrect nest management, incorrect flock distribution, high stocking density, wrong illumination, uncomfortable nest, Incorrect trained pullets, incorrect lighting program, incorrect feeding program, incorrect light distribution, excessive litter depth, delayed removal of old floor eggs
Poor feather coverage	See Feather pecking
Feather pecking	Incorrect feed distribution, incorrect feed formulation, light intensity, incorrect light bulbs, incorrect feed intake, and/or distribution
Nest piling	Less nest box space, bad distribution of layers in the barn
Panic piling	Unexpected noise, unbalanced nutrition or feed distribution, feed deliveries at night, vehicle headlight shock

Key Points

- ▶ Ensure a gain in body weight and correct development to maintain egg production.
- ▶ Correct management of feed distribution and feeding times.
- ▶ Monitor body weight and feather covering.
- ▶ Monitor production outputs to enable corrective measures as soon as possible.
- ▶ Monitor feed and water intake.
- ▶ Work hard for first production weeks to control floor eggs and later on keep it under control
- ▶ Avoid stress factor leading to feather pecking or piling episodes
- ▶ Be analytical with piling episode to trying to understand the reason behind and find out the corrective measures.



PRODUCTION UP TO > 100 WEEKS

- ▶ How to manage the flock to achieve longer production cycles.
- ▶ How to decrease mortality during the late production period.

EGGSHELL QUALITY

Body weight at 5–6 weeks of age

The carcass of the hen is mainly developed during the first 5–6 weeks of age. A loss of body weight in this period will reduce the longevity of the layer hen impacting on the eggshell quality during the production period.

Correct use of Hybrid Feed

Incorrect use of hybrid feed might induce damage to the medullary bone, affecting the capability of the layer hen to utilize Ca from the bone.

Feed Intake Development using a Developer Feed

At the start of lay a lack of feed intake will force the layer hen to exert metabolic effort that will compromise the longevity of the hen (see more in chapter on nutrition).

Calcium Sources

60–70 % of Ca in the eggshell derives from the diet and 30–40 % from the bones, especially the medullary bone. The availability of Ca during eggshell formation will improve eggshell quality. Particle size and solubility of the Ca sources (see more in chapter on nutrition) are strategies to improve eggshell quality.

Balanced Ca, P and Vit D in Diet

Excess or deficiencies will trigger eggshell challenges (see more in chapter on nutrition).

Use of organic trace Minerals

Trace minerals are part of the inner eggshell and in eggshell formation through the enzymes. Use could be justified when, as the egg size increases, the eggshell becomes thinner.



Medullary bone in young hen



Medullary bone in old hen

GOOD LIVER HEALTH

- Adding fat and oil or crude fat in layer diets is a well-known tool to reduce the incidence of “fatty liver syndrome”.
- Added choline chloride in layer diets to support liver metabolism.
- Methionine and betaine are used to relieve liver metabolism.
- Vitamins like K₃, E, B₁₂, B₁ and folic acid.
- Mycotoxin control is a must.

List of mycotoxins

Aflatoxins	Fatty liver, liver necrosis and bile duct hyperplasia
Fumonisin	Multifocal hepatic necrosis; hepatocellular hyperplasia
Aflatoxin + T2	Pale enlarged liver

REDUCE THE METABOLIC CHALLENGES

Oxidative Stress

Physiological stress on the body that is caused by the cumulative damage done by free radicals inadequately neutralized by antioxidant system and that is held to be associated with aging.

- **Free radicals:** they are produced during metabolism when ATP is produced, as part of the inflammatory response, heat or cold,

stress, high levels of ammonia, oxidized fat in diet.

- **Antioxidant system:** it is a complex system involving enzymes, as glutathione dependent of Cys availability or like super oxide dismutase, vitamins and minerals as co factors of the enzymes.
- **Symptoms:** unspecific mortality as the hens age and feather loss increases.

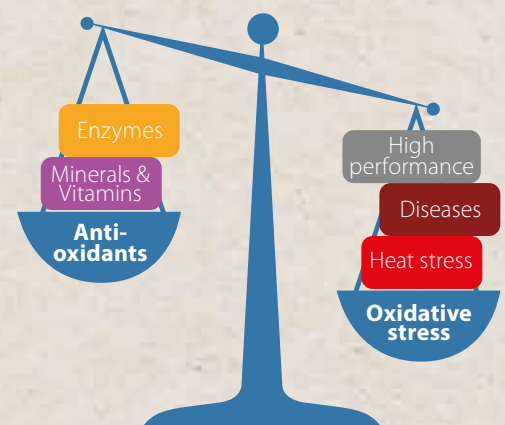

PRODUCTION UP TO > 100 WEEKS

System Fatigue

It is a decalcification of the bones of the hens when there isn't a balance of the Ca, P and vitamin D in the diet.

- Ca levels should increase as the birds get older
- P levels should be reduced as the birds get older
- Vitamin D deficiency

Needs of Ca and available P in production

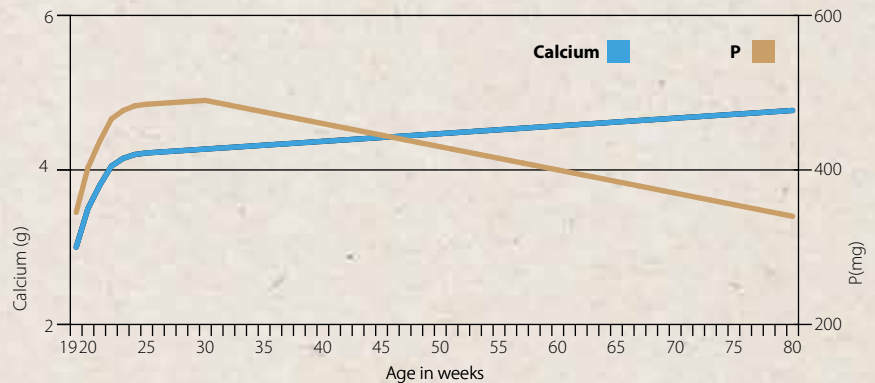

IMPROVE GUT HEALTH

Feed Hygiene

Try to reduce contamination as much as possible.

- HACCP quality system to control raw materials and final product quality
- Addition of additives that can reduce contamination in the feed

Don't forget to monitor the water quality.

Stimulate Gizzard Activity

The gizzard is the first natural barrier for contaminants in the feed. Increasing its activity will reduce the pH thereby improving the

barrier and improving the digestion of nutrients. This reduces the availability of nutrients used for the growth of the pathogens in the lower part of the gut.

Gut Health Additives

Find the best combination of gut health additives to reduce the growth of the pathogens in the gut. The combination should be based on the area of action, level of pathogens in the area and other challenges.

- Enzymes; essential oils; organic acids; prebiotics; probiotics

	Mash CFU log/gr	Pellet/ crumble CFU log/gr
Enterobacteria	< 3	< 1.5
Escherichia coli	< 1	< 1
Anaerobic sulfite reducers at 46 °C	< 1	< 1
Salmonella	0	0
Molds	< 3	< 1.5
Yeast	< 3	< 1.5

FACTORS INFLUENCING EGG SIZE

Energy

In cage free production the needs of the birds are increasing. The source of energy could become amino acids limiting egg size. Therefore be sure that the energy intake is adjusted in cage free diets (see nutrition) methionine & other amino acid intake methionine is the first limiting amino acid in egg weight. However if we want to control the egg size, we need to do it with the whole amino acid profile so the ideal protein ratio isn't broken.

Linoleic Acid

There is a minimum requirement of linoleic acid, so the egg yolk size isn't a limitation in the egg size. Need to be careful when raw materials with low linoleic acid are used.

Added Fat

Adding fats, vegetable or animal fats, in the diet increases the egg size. It improves the feed efficiency and reduces the dustiness of the feed.

Weight of the Birds

Birds with high body weight (above the standard) at week 5 will produce bigger eggs. It isn't recommended to have birds below the standard at week 5 (no more than 3 %) to control egg weight in production, performance will be compromised.



Key Points

- ▶ When keeping hens for a longer lay-cycle, be proactive at an early age.
- ▶ Start to collect eggs two times a day to continue egg quality in older flocks.
- ▶ Poor eggshell quality is a major cause for lower saleable eggs output in the late production period. Take corrective measures in advance.
- ▶ Avoid immunosuppression by avoiding mycotoxins, stress or poor nutrition.
- ▶ A healthy liver offers excellent egg production. Take care of it.
- ▶ Good gut health is needed to properly assimilate the nutrients, pay attention to it.

EGG QUALITY

- ▶ How to identify eggshell quality defects and the causes.
- ▶ How to identify internal quality defects and the causes.

EGGSHELL QUALITY

Problem	Causes	
<p>Cracked/broken eggs: large cracks and holes</p> <ul style="list-style-type: none"> ▪ % in production: increases with the age of the hen. 1–5 % of total production 	<ul style="list-style-type: none"> ▪ Old birds (> 50–60 weeks) ▪ Mineral deficiencies or imbalance ▪ Saline water ▪ Diseases with ovary tropism ▪ High temperatures ▪ Mechanical damage during collection 	
<p>Hairline cracks: very fine cracks that require efficient candling</p> <ul style="list-style-type: none"> ▪ % in production: varies with the age and the % of cracked or broken eggs 	<ul style="list-style-type: none"> ▪ Old birds (> 50–60 weeks) ▪ Mineral deficiencies or imbalance ▪ Saline water ▪ Diseases with ovary tropism ▪ High temperatures ▪ Mechanical damage during collection ▪ Infrequent egg collection 	
<p>Star cracks: fine cracks radiating outwards from a central point of impact</p> <ul style="list-style-type: none"> ▪ % in production: varies with the age, 1–2 % of the total production 	<ul style="list-style-type: none"> ▪ Old birds (> 50–60 weeks) ▪ Mineral deficiencies or imbalance ▪ Saline water ▪ Diseases with ovary tropism ▪ High temperatures ▪ Mechanical damage during collection ▪ Infrequent egg collection 	
<p>Shell-less eggs and thin shelled: no shell or very thin shell, very easy to break</p> <ul style="list-style-type: none"> ▪ % in production: varies 0.5–6 %. High levels possible with pullets in early maturity 	<ul style="list-style-type: none"> ▪ Immature shell gland ▪ Disrupted deposition of calcium in shell ▪ Mineral deficiencies or imbalance ▪ Saline water ▪ Diseases with ovary tropism ▪ Mechanical damage during collection ▪ Infrequent egg collection 	
<p>Sandpaper or rough shell: eggs with rough texture areas unevenly distributed over the shell</p> <ul style="list-style-type: none"> ▪ % in production: the incidence should be < 1 % 	<ul style="list-style-type: none"> ▪ Diseases with ovary tropism and avian encephalomyelitis ▪ Disrupted egg oviposition or egg retention ▪ Sudden increase of light during lay ▪ Water shortage 	
<p>Misshapen eggs: shell marred by flat sides or body checks (ribs or grooves)</p> <ul style="list-style-type: none"> ▪ % in production: can rise to 2 % at start of lay and later almost disappear unless there is an issue 	<ul style="list-style-type: none"> ▪ Immature shell gland ▪ Diseases with ovary tropism ▪ Stress caused by frights and disruption ▪ Crowding 	

EGGSHELL QUALITY

Problem	Causes	
<p>Flat sided eggs: part of the shell is flattened</p> <ul style="list-style-type: none"> ▪ % in production: < 1 % 	<ul style="list-style-type: none"> ▪ Diseases with ovary tropism and avian encephalomyelitis ▪ Disrupted egg deposition ▪ Sudden increase of light during lay ▪ Crowding 	
<p>Pimples: small lumps of calcified material on the eggshell</p> <ul style="list-style-type: none"> ▪ % in production: around 1 % is common 	<ul style="list-style-type: none"> ▪ Old birds ▪ Excess of Ca ▪ Sudden increase of light during lay ▪ Crowding 	
<p>Pinholes: small holes in the eggshell</p> <ul style="list-style-type: none"> ▪ % in production: < 0.5% 	<ul style="list-style-type: none"> ▪ Old birds ▪ Mineral deficiencies or imbalance ▪ Damage caused by hen or sharp objects in cages or collection conveyor 	
<p>Mottled or glassy shell: appears mottled at candling</p> <ul style="list-style-type: none"> ▪ % in production: not usually undegraded unless the condition is obvious. Incidence varies 	<ul style="list-style-type: none"> ▪ High humidity in the layer house ▪ Mineral deficiencies ▪ Crowding ▪ Diseases with ovary tropism and infection ▪ bursal disease in parent stocks 	

EGG QUALITY

ALBUMEN QUALITY

Description	Causes
Physiological	Age of bird
Management	High temperature of storage. Heat stress
Diseases	Bronchitis, Newcastle
Nutrition	Low CP or Lys diets Low level of vitamin E or C during heat stress Low levels of trace minerals
Contamination	Vanadium

Temperature

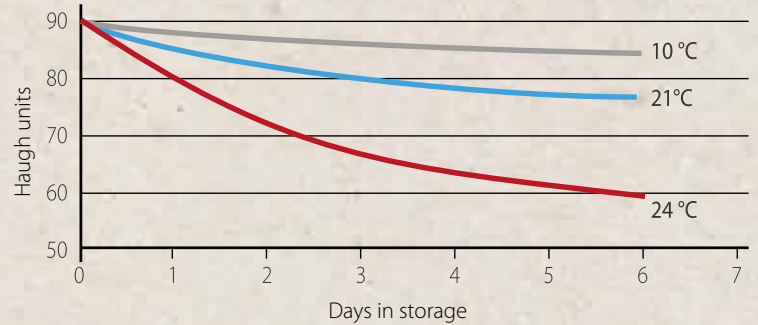

YOLK QUALITY

Problem	Causes	
<p>Blood spots: blood spots on the surface of the yolk</p> <ul style="list-style-type: none"> % in production: incidence varies, 5–8 % 	<ul style="list-style-type: none"> Deficiencies in vitamin A and K Fungal toxins Continuous light programs or intermittent light periods Fright and disruption Avian encephalomyelitis 	
<p>Meat spots: brown colored, pieces of tissue of the ovary or partially broken-down blood spots</p> <ul style="list-style-type: none"> % in production: 1–3 % 	<ul style="list-style-type: none"> Deficiencies in vitamin A and K Fungal toxins Continuous light programs or intermittent light periods Fright and disruption Avian encephalomyelitis 	
<p>Pale yolks: the egg yolk doesn't have the expected color</p> <ul style="list-style-type: none"> % in production: incidence varies based on the issue 	<ul style="list-style-type: none"> Gut health issues Mycotoxines Liver damage Oxidation of the added pigments Wrong mixing of the pigments 	



Key Points

- ▶ Internal and external egg quality is a powerful tool to address production issues.
- ▶ A certain percentage of defects is considered normal.
- ▶ Correct egg management is the best way to improve internal and external egg quality.

FREE-RANGE & ORGANIC PRODUCTION

Pullets

- To prepare the pullets for these types of production systems there are some countries who require that birds are using the range area already in the rearing period.
- Use the right lighting program to prepare the pullets in the right way for the good start in production.
- **Points of attention:**
 - Use of dark rearing house, or with day-light influence
 - Season of the year (daylength)
 - Please look at our light program recommendation.

Paddocks

When local legislation allowed make different paddocks (3–4) to give the layers every 4–8 weeks access to some other paddock to give the other paddocks time to recover. In that time you can clean the empty paddocks, and grass and soil can recover.

Veranda / Wintergarden

- We recommend the use of a veranda / wintergarden to make a barrier between the barn and the pasture range area.

With this there is a possibility to start a small training for pullets/layers to go in and outside the barn in-between, to make the step to use the complete range area. This barrier is also useful as shelter for weather conditions which can affect climate and litter quality inside the barn.

- Make a clean entry into the barn / wintergarden with the use of material that absorbs moisture and dirt in the first meters of the pasture area. This to avoid the occurrence of mud pools in rain periods. For this you can use concrete, stones, or grinds tree roots, with or without drainage in the first 5–10 meters from the barn.

Climate Control

- When rearing / production house is preparing for free-range / organic please look for possibilities to update climate control to keep climate and litter quality good.
- Close popholes during inclement weather, if permitted by local regulation.
- Look for the possibilities to use climate control with equal pressure ventilation, or a day and night settings to control the time's that pop holes are open and closed.

IMPORTANT



Regulations for free-range / organic rearing and production can be different for each country. These regulations are based on:

- Age when layers need to go outside.
- Divide the range area in 3–4 different areas and use every 4–5 weeks an other range. with this the other areas can recover.
- Amount and position of land
- Numbers and format of pop holes
- Placement pop holes to pasture range area
- Time to open and close the pop holes during the day
- Separate range areas for maximum numbers of pullets / layers
- Use of trees and shelters in the pasture range area



Clean, concrete, stones, tree roots for entrance barn or wintergarden



Open Pop holes



Closed Pop holes



Under pressure climate control system in free-range barn

FREE-RANGE & ORGANIC PRODUCTION

Pasture range

Pasture range area needs to be clean and dry to avoid the occurrence of mud pools as much as possible.

- Check the health condition of the previous flock, and when needed take some extra care for the pasture area.
- When needed clean and reseed this area.
- Cleaning can do to bring 500 gram/m² quicklime on the pasture range, before reseeded.
- Use trees and shelters to protect for climatic conditions (sunlight/rain) and for predators coming from the sky. With this you stimulate the layers to use the pasture range complete.

Fencing

- To keep the pullets/layers inside, and predators outside the pasture range you need to take care of a good fencing.
- When needed also fencing to make different compartments inside the complete pasture range
- The best fence is about 2 meters high with electric wire at the top (when allowed) to protect foxes or similar predators. It must

be 50 cm deep underground to act as an anti-tunneling barrier.

Predation

Predation is a problem to be considered when birds have access to an outdoor run as hens are often easy prey. Several national studies report that this can reach between 0.5 % and 29 % of all mortality in free-range systems.

There are mainly two types of predator:

- **Terrestrial predator:** foxes may be a hackneyed example but in different ecosystems it is possible to find other types of animals such as minks, badgers, snakes or even dogs. Many of these tend to be nocturnal predators.
- **Birds of prey:** Goshawks, harriers and buzzards are among the bird species involved but these may also vary depending on geographical location and ecosystem. They are usually diurnal hunters.

Predation damage is not only due to the killing of healthy, productive hens, but also to the effect of stress production on the hunting process. This is especially severe for some terrestrial predators.

It is common to have an episode of smothering, feather pecking or cannibalism during, just after or in the days following a predation episode.

How to reduce predation:

- Complete fencing of all outdoor parks. Hen houses must be entry-proof for foxes or other nocturnal ground predators.
- Outdoor parks must be free of abandoned objects and grass clippings to prevent predators from easily stalking hens.
- Overhead netting can be used to prevent attacks by birds of prey in some areas of the outdoor parks.
- It must be ensured that all birds enter the house before dusk.
- The use of alpacas as guards against predators in the outdoor park seems to be successful. The use of dogs as guards has negative results in many cases and probably both (hens and dogs) will need special training.



Clean, dry pasture range



Pasture range with water puddle, no grass



Trees in pasture range



Shelter in pasture range



Good fencing on pasture range

FREE-RANGE & ORGANIC PRODUCTION

RANGE MANAGEMENT

- Work with the right lighting program in rearing/production, to make it easier to bring ALL the pullets/layers back inside the barn for the night.
- Try to give the birds a good breakfast before they go outside to the pasture range.
- Possible to train the pullets already in rearing to go back inside when the feeders start to run!
- Few minutes before feeders start to run, there is the sound of a bell. After doing this during the rearing period, you can use this ring sound also outside the barn, to track the birds to go inside for eating.
- To control climate better during evening/night close the pop holes during this period (when local regulations allowed).
- In some countries the birds need to have 24/7 access to the wintergarden.

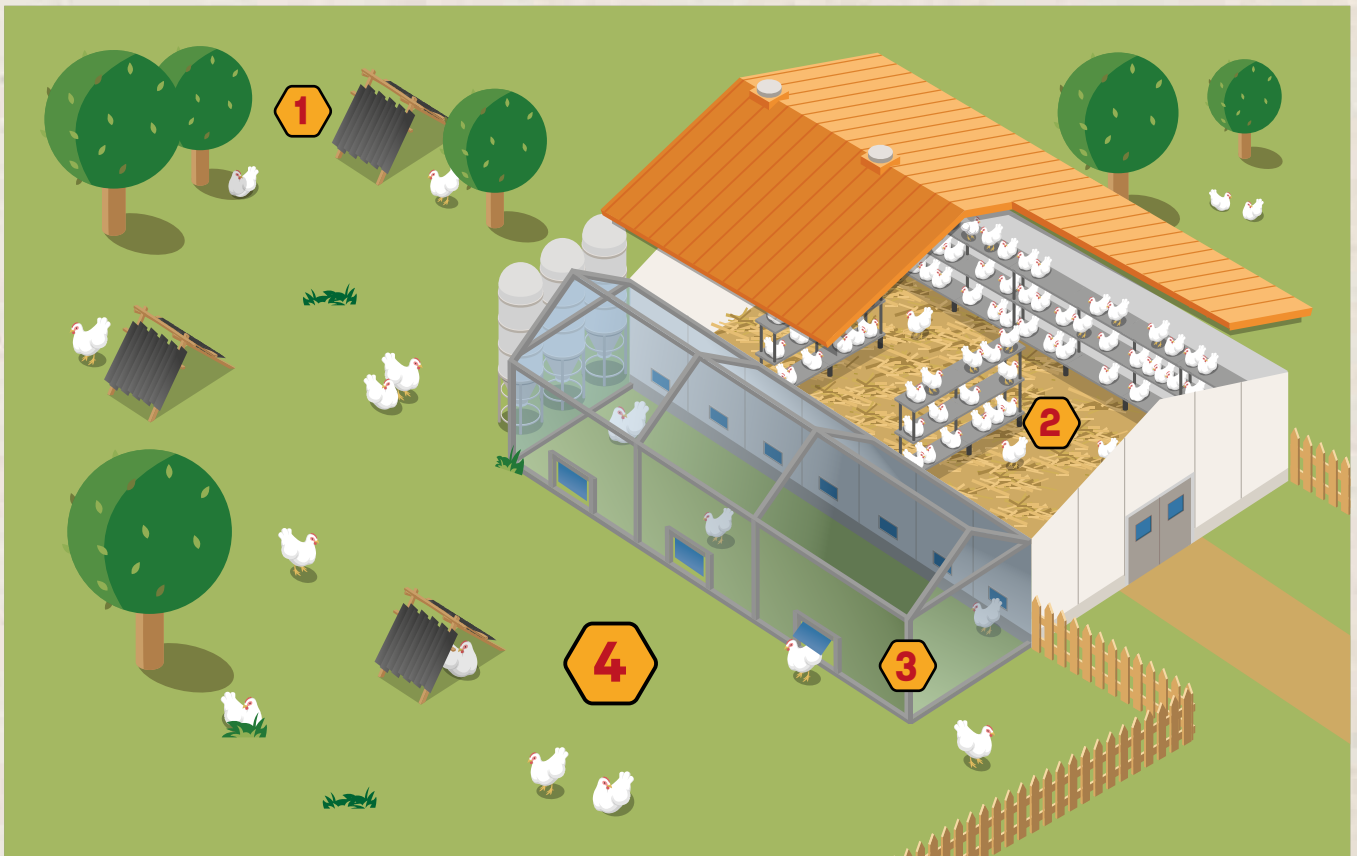

- 1** Shelters **2** Feed – Water – Nest boxes **3** Wintergarden **4** Outdoor pasture

Key Points

- ▶ Start with a clean and empty pasture area with start of a new flock.
- ▶ Prepare the pullets with a lighting program that corresponds to the time of the year.
- ▶ It is recommended to use a veranda or wintergarden to make a barrier between barn and pasture range.
- ▶ Check the climate system to work the best during day and night period.
- ▶ Avoid the occurrence of mud pools.
- ▶ Use a good fencing to keep predators outside the pasture area and barn.
- ▶ Be sure that all the layers are inside the barn at night.



NUTRITION

Rearing Nutrition

- ▶ How to develop the skeleton and muscle of the pullet at each phase.
- ▶ How to develop the feed intake capacity for the start of lay.

Feed Description and Management

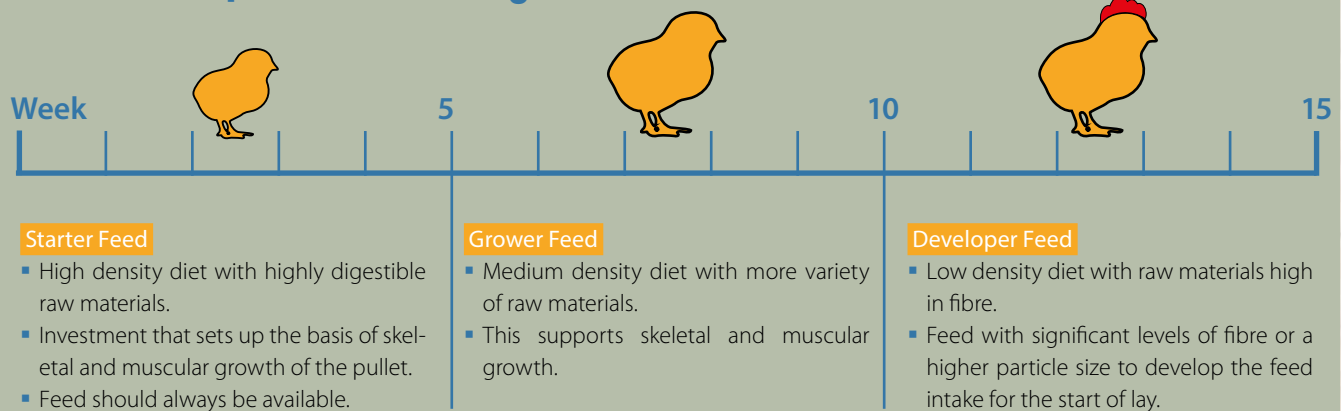

Changing diets

- Delay a change to the diet if the target body weight is not reached.
- If the body weight isn't achieved by 5 or 11 weeks of age, there is a need to review the nutrition, density and management in the previous weeks.
- If the birds are over the target body weight, the change to the next diet can be done a week earlier.

Formulation Tips

Starter

- Crumble feed presentation will improve growth and make it easier to reach the standard body weight.
- It could be interesting to invest in highly digestible raw materials if they are available.
- Soya oil or coconut oil are better sources of energy than palm oil: at least during the first three weeks of age.
- A minimum of 0.30 % of salt will help to increase feed intake.

Grower

- Transition to mash feed if the starter was crumble feed.
- A minimum of 0.28 % of salt will help to have enough feed intake.

- A minimum of added fat will reduce the dustiness of the mash feed (1 – 2 % based on cost impact).

Developer

- Crude fibre level needs to be as high as possible based on the available raw materials (>3 %, up to 5.5 %). See possible raw materials to supply the necessary fibre (table 9). These values can be applied, or even exceeded, as long as they are of good quality.
- If the available raw materials don't allow you to follow the recommendations below. Your Nutritionist should make a proportionally higher specification and the feed mill needs to make a higher particle size feed to compensate the lack of fibre.
-

- A minimum of added fat will reduce the dustiness of the mash feed (1 – 2 % based on cost impact).

Others

- Calcium particle size in pullet feed should be fine (average 1 mm).
- Enzymes: use and effect in the diet should be based on the available substrate in the diet.
- Antioxidants: protect against oxidation of the oils in the feed mill and the oxidation of fats and others in the diet.
- Organic minerals: provide additional benefits to the existing inorganics and may reduce the inclusion levels of the minerals.

Nutrient Requirements

Fibre in the diet

- The feed intake development is one of the key factors for developing a pullet ready to lay. The feed intake capacity is related to the gut size, the addition of fibre in the diet expands the size of the gut and improves the feed intake capacity.
- The fibre concept is getting complex in poultry. There is new knowledge showing how different types have a different effect.

- Fibre can be classified like:
The total dietary fibre (TDF) is a sum of water soluble fibre (WSF), neutral detergent fibre (NDF), acid detergent fibre (ADF) crude fibre (CF) and acid detergent lignin (ADL).
- The addition of certain level of fibres since early ages will support the feed intake capacity (see table 10).
- There are several raw materials that can supply the necessary fibre in the diets to develop the feed intake capacity (table 9)

Energy

- The energy requirement in feed is given as a range because of the several systems available for energy evaluation.

Amino Acids

- They follow the recommended Ideal Protein Ratio (table 7)

Vitamins and Minerals

- See table 8

Table 6: Nutrient recommendations for rearing period

Nutrient		Starter	Grower	Developer
		0 – 5 weeks	6 – 10 weeks	11 – 17 weeks
M Energy	Kcal/kg MJ/kg	2825 – 2950 11.83 – 12.35	2725 – 2850 11.41 – 11.93	2600 – 2750 10.89 – 11.51
Crude protein	%	20-19	18-17	15.5-14.5
Lysine	%	1.15	0.94	0.64
Dig. Lysine	%	0.98	0.80	0.54
Methionine	%	0.51	0.42	0.30
Dig. Methionine	%	0.43	0.36	0.25
Met. + Cysteine	%	0.86	0.75	0.54
Dig. Met + Cys	%	0.74	0.64	0.46
Threonine	%	0.76	0.65	0.44
Dig. Threonine	%	0.65	0.56	0.38
Tryptophane	%	0.22	0.20	0.15
Dig. Tryptophane	%	0.19	0.17	0.13
Isoleucine	%	0.80	0.72	0.48
Dig. Isoleucine	%	0.68	0.61	0.41
Valine	%	0.90	0.73	0.51
Dig. Valine	%	0.76	0.62	0.43
Argenine	%	1.21	0.99	0.67
Dig. Argenine	%	1.03	0.84	0.57
Calcium	%	1.05	1.00	0.90
Total Phosphorus*	%	0.75	0.7	0.58
Available Phosphorus*	%	0.48	0.45	0.37
Dig. Phosphorus*	%	0.41	0.38	0.32
Sodium minimum	%	0.18	0.17	0.16
Potassium minimum	%	0.50	0.5	0.50
Potassium maximum	%	1.10	1.10	1.10
Chloride minimum	%	0.20	0.18	0.16
Salt minimum	%	0.30	0.28	0.26
Choline total	mg/kg	1260	1240	1200

* without phytase

Table 7: Ideal Protein Ratio in rearing

	Starter	Grower	Developer
Lysine	100 %	100 %	100 %
Metethionine	44 %	45 %	47 %
Met. + Cys.	75 %	80 %	85 %
Threonine	66 %	70 %	70 %
Tryptophane	19 %	21 %	24 %
Ile	69 %	76 %	76 %
Valine	78 %	78 %	80 %
Arginine	105 %	105 %	106 %

Table 8: Vitamin and trace mineral recommendation in rearing

		Starter / Grower	Developer
Vitamin A*	IU	10000	10000
Vitamin D ₃	IU	2000	2000
Vitamin E	IU	20 – 30	20 – 30
Vitamin K ₃	mg	3**	3**
Vitamin B ₁	mg	1	1
Vitamin B ₂	mg	6	6
Vitamin B ₆	mg	3	3
Vitamin B ₁₂	mcg	15	15
Pantothenic acid	mg	8	8
Nicotinic acid	mg	30	30
Folic acid	mg	1.0	1.0
Biotin	mcg	50	50
Cholin	mg	300	300
Cocciostat		as required	as required
Manganese	mg	100	80
Zinc	mg	70	60
Iron	mg	25	25
Copper	mg	10	10
Iodine	mg	0.5	0.5
Selenium	mg	0.3	0.3

* Higher level might be possible according to local state and national regulations.

** double in case of heat treated feed

Table 9: Inclusion level of raw materials rich in fibre

Raw material	Range (%)
Rice bran	5 – 15
DDGs	5 – 20
Wheat bran	10 – 20
Wheat pollard	10 – 25
Bakery by-products	5 – 10
Barley sprouts	5 – 8
Copra meal	5 – 10
Palm kernel meal	2 – 8
Sunflower meal	5 – 15
Lupins	5 – 10
Oat hulls	2 – 4
Soya hulls	2 – 4

Table 10: Crude fibre levels in rearing

	0 – 5 weeks	6 – 10 weeks	11 – 17 weeks
Minimum	3 %	3.5 %	4 %
Maximum	4 %	5 %	6.5 %

HYBRID FEED FOR ONSET OF LAY NUTRITION

► How to develop feed intake as the bird is growing and laying its first egg.

Feed Description and Management

- A transition feed that supports the final development of the pullet and the nutrient need for the start of lay.
- This feed is recommended to use until you reach 70 % of laying rate and have an increasing feed intake curve.
- This feed could be given since week 17 as replacement of the old concept of the pre-lay.

Nutrient Requirements

- The ideal protein profile is the same as in the layer rations.
- The vitamins and minerals are the same as in the layer rations.
- Crude fibre: keeping high levels as in the developer feed supports the feed intake development.
- Try to have a level minimum of 3.5 % or higher.

Formulation Tips

- The addition of fats will give the formulation room for the requested calcium and fibre.
- A minimum of salt, 0.28 %, will help in the feed intake stimulation.
- 60 % of the calcium carbonate should be in coarse particle size

Table 11: Nutrient recommendations for the Onset period

Nutrient					
Energy		265 – 275 kcal/hen/day 1.109 – 1.151 MJ/hen/day			
Crude protein		16.0 g/hen/day			
		mg / hen / day	90	95	100
Lysine	%	847	0.941	0.892	0.847
Dig. Lysine	%	720	0.800	0.758	0.720
Methionine	%	424	0.471	0.446	0.424
Dig. Methionine	%	360	0.400	0.379	0.360
Met. + Cysteine	%	762	0.847	0.802	0.762
Dig. Met + Cys	%	648	0.720	0.682	0.648
Threonine	%	593	0.659	0.624	0.593
Dig. Threonine	%	504	0.560	0.531	0.504
Tryptophane	%	186	0.207	0.196	0.186
Dig. Tryptophane	%	158	0.176	0.167	0.158
Isoleucine	%	678	0.753	0.713	0.678
Dig. Isoleucine	%	576	0.640	0.606	0.576
Valine	%	741	0.824	0.780	0.741
Dig. Valine	%	630	0.700	0.663	0.630
Argenine	%	881	0.979	0.927	0.881
Dig. Argenine	%	749	0.832	0.788	0.749
Sodium	%	180	0.200	0.189	0.180
Potassium	%	500	0.556	0.526	0.500
Chloride	%	180	0.200	0.189	0.180
Calcium	%	360	4.00	3.790	3.60
Phosphorus	%	600	0.667	0.630	0.600
Avail. Phosphorus	%	420	0.467	0.440	0.420
Dig. Phosphorus	%	360	0.400	0.380	0.360

Laying Nutrition

► How to feed hens for achieving as many as saleable eggs as possible during the laying period.

Feed Description and Management

Type of Feed

▪ The feed should fulfill the maintenance, growth and production needs. The feed should be adjusted when:

- **Egg mass changes:** DO NOT change amino acids if the % lay drops unless the egg mass (% lay x size egg) is dropping too;

- **Body weight changes:** body weight affects energy needs, around +/-4 kcal every 50 grams of body weight change;
- **Calcium and phosphorus requirement changes:** the phosphorus requirement decreases and the calcium requirement increases as the bird gets older;

- **Feed intake changes:** housing temperature will impact the feed intake. Hot temperature reduces the feed intake and vice versa.

Chart 1: Flow diagram based on raw materials variability through the feed management on farm

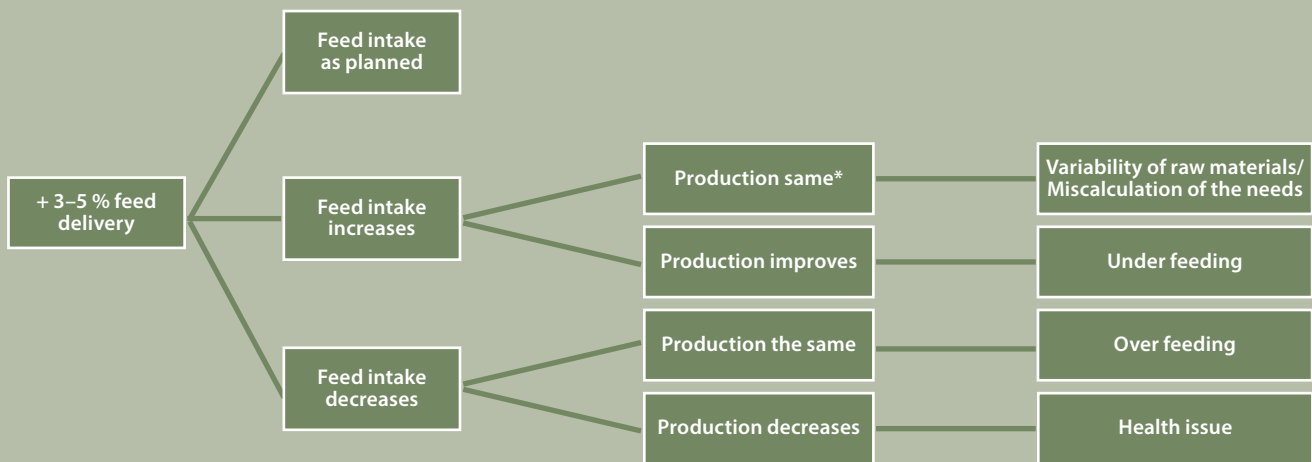

* In absence of spilled feed

Chart 2: Daily feed intake pattern

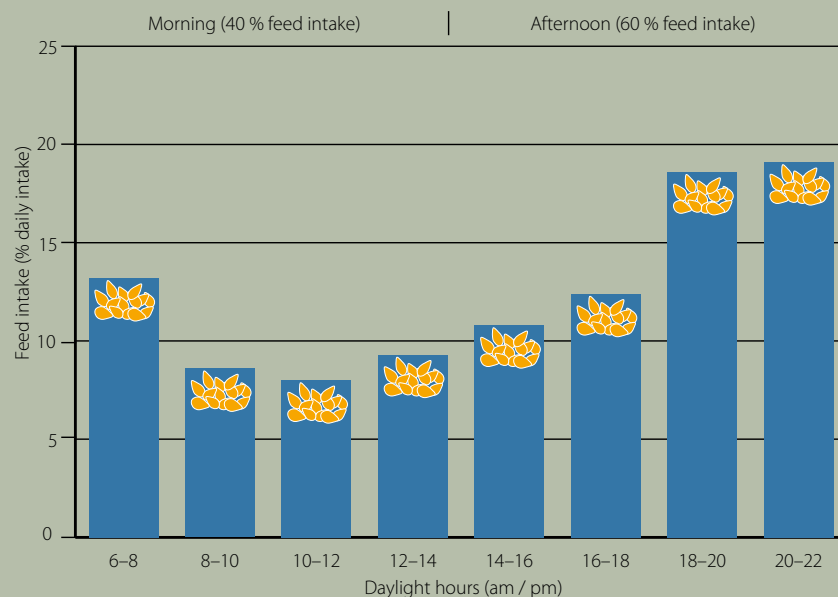

adapted from Keshavarz, 1998

Feed Management on Farm

- Due to the variability of the raw materials the nutrient composition of the feed varies, to avoid this challenge we recommend to follow the Chart 1 decision tree:

Feed Recommendation

- Layer hens should clear all feed left in the feeder during the noon period.
- The time at which the feeder is empty depends on the lighting program.

Nutrient Requirements

- Recommendations below are based on egg mass production.
- After the Onset feed it is recommended to use the 60–58 egg mass recommendation until the target egg weight is achieved. The other recommendations can be applied to control the egg size on target or when the egg mass production drops as the layer hen gets older.

Energy

- The energy recommendation of this guide doesn't take into account the effect of the temperature in the needs of the layer hen. It needs additional adjustments by the nutritionist.
- Most of the energy intake will be used for maintenance. However in cage free production there will be an additional need of energy, for the activity of the bird in the system. We have estimated that the

needs will be a 8 % of the maintenance needs (see chart 3).

- There are different models to approach the energy evaluation, literature references (INRA, FEDNA, NRC ...) usually in MEn and calculations based on formulas, whereby the different elements of the raw materials are taken into account. Due to the variability of the values given by different systems, the recommendation of energy is defined as a range.

- Energy recommendation is calculated for a specific body weight of the bird and might need adjustments (see foot notes of table 12).

Amino Acids

- Most of the amino acid intake will be used for egg mass production. The egg mass, % lay x egg size, drives the amino acid needs (chart 4)
- The total amino acid recommendation is

based on a feed with 85 % digestibility. It will need further adjustments by the nutritionist based on the digestibility of the diets of each customer. The formulation can be done using total or digestible AA. Do not use both values at the same time.

- Working with digestible AA is highly recommended when low digestible raw materials are used in the diet (see table 20 for the Ideal Protein Ratio recommendation).

Minerals and Vitamins

- The vitamin and mineral requirement is shown in table 17.

Ca/P

- Ca and P requirement is shown in table 16.
 - Adapt the data in table 11 to suit the feed intake target.
 - Example: Av P requirement after peak 380 mg; if feed intake is 115 grams, the minimum amount in feed should be 0.33 %.

Chart 3: Daily requirements of energy of the bird

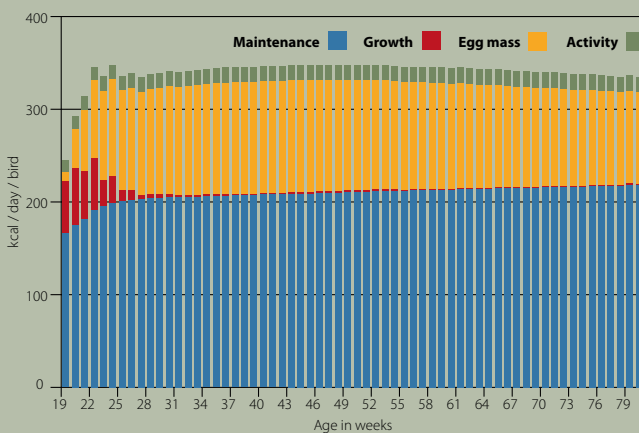
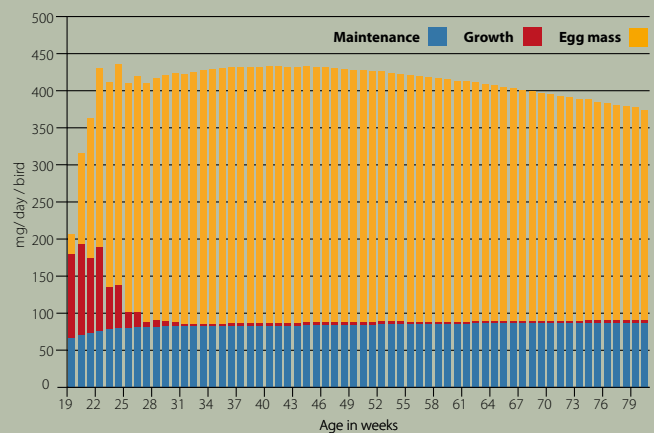

Chart 4: Daily requirements of digestible Methionine



Formulation Tips

Crude Protein

- Using the minimum amount of crude protein is recommended if there is limited information about the raw materials.

Fat

- Added fat will reduce the dustiness of mash feed (1 – 2 % based on cost impact).

Ca/P Balance

- Levels of Ca and P must be adapted as the layer hen gets older.
- An excess or deficiency of P can cause eggshell issues in the short or long term.
- Coarse limestone is necessary for eggshell quality. It can be replaced in part by oyster shells.
- Table 19 indicates the limestone particle ratio in layers.
- Table 18 indicates how much grit should be added directly to the feeding system.

Others

- Enzymes: use and effect in the diet should be based on the available raw materials in the diet.
- Antioxidants: protect against oxidation of the oils in the feed mill and the oxidation of fats and others in the diet.
- Organic minerals: provide additional benefits to the existing inorganics and may reduce the inclusion levels of the minerals.

NUTRITION

Table 12: Nutrient requirement for a daily egg mass target of 60 – 58 g/hen

Nutrient						
Energy		300 – 316 kcal/hen/day 1,257 – 1,323 MJ/hen/day				
Crude protein		17.5 g/hen/day				
		mg / hen / day	105	110	115	120
Lysine	%	947	0.902	0.861	0.824	0.789
Dig. Lysine	%	805	0.767	0.732	0.700	0.671
Methionine	%	474	0.451	0.430	0.412	0.395
Dig. Methionine	%	403	0.383	0.366	0.350	0.335
Met. + Cysteine	%	871	0.830	0.792	0.758	0.726
Dig. Met + Cys	%	741	0.705	0.673	0.644	0.617
Threonine	%	663	0.631	0.603	0.576	0.552
Dig. Threonine	%	564	0.537	0.512	0.490	0.470
Tryptophane	%	227	0.216	0.207	0.198	0.189
Dig. Tryptophane	%	193	0.184	0.176	0.168	0.161
Isoleucine	%	758	0.722	0.689	0.659	0.631
Dig. Isoleucine	%	644	0.613	0.585	0.560	0.537
Valine	%	829	0.789	0.753	0.721	0.691
Dig. Valine	%	704	0.671	0.640	0.613	0.587
Argenine	%	985	0.938	0.895	0.856	0.821
Dig. Argenine	%	837	0.797	0.761	0.728	0.698
Sodium	%	190	0.181	0.173	0.165	0.158
Potassium	%	500	0.476	0.455	0.435	0.417
Chloride min.	%	190	0.181	0.173	0.165	0.158
Chloride max.	%	310	0.295	0.282	0.270	0.258
Linoleic acid	%	1550	1.476	1.409	1.348	1.292

* The energy needs are calculated for a body weight of 1660 g. Every 50 g of change will have an impact of +/- 4 kcal / bird / day

Table 13: Nutrient requirement for a daily egg mass target of 57 – 55 g/hen

Nutrient						
Energy		295 – 310 kcal/hen/day 1,233 – 1,298MJ/hen/day				
Crude protein		18.0 g/hen/day				
		mg / hen / day	105	110	115	120
Lysine	%	0.880	0.840	0.803	0.770	0.753
Dig. Lysine	%	0.748	0.714	0.683	0.654	0.640
Methionine	%	0.440	0.420	0.402	0.385	0.376
Dig. Methionine	%	0.374	0.357	0.341	0.327	0.320
Met. + Cysteine	%	0.809	0.772	0.739	0.708	0.693
Dig. Met + Cys	%	0.688	0.657	0.628	0.602	0.589
Threonine	%	0.616	0.588	0.562	0.539	0.527
Dig. Threonine	%	0.523	0.500	0.478	0.458	0.448
Tryptophane	%	0.211	0.201	0.193	0.185	0.181
Dig. Tryptophane	%	0.179	0.171	0.164	0.157	0.154
Isoleucine	%	0.704	0.672	0.642	0.616	0.602
Dig. Isoleucine	%	0.598	0.571	0.546	0.523	0.512
Valine	%	0.770	0.735	0.703	0.673	0.659
Dig. Valine	%	0.654	0.624	0.597	0.572	0.560
Argenine	%	0.915	0.873	0.835	0.800	0.783
Dig. Argenine	%	0.778	0.742	0.710	0.680	0.666
Sodium	%	0.181	0.173	0.165	0.158	0.148
Potassium	%	0.476	0.455	0.435	0.417	0.435
Chloride min.	%	0.181	0.173	0.165	0.158	0.148
Chloride max.	%	0.295	0.282	0.270	0.258	0.256
Linoleic acid	%	1.476	1.409	1.348	1.292	1.348

* The energy needs are calculated for a body weight of 1660 g. Every 50 g of change will have an impact of +/- 4 kcal / bird / day

Table 14: Nutrient requirement for a daily egg mass target of 54 – 52 g/hen

Nutrient						
Energy		289 – 304 kcal/hen/day 1,209 – 1,273 MJ/hen/day				
Crude protein		17.0 g/hen/day				
		mg / hen / day	105	110	115	120
Lysine	%	876	0.835	0.797	0.762	0.730
Dig. Lysine	%	745	0.710	0.677	0.648	0.621
Methionine	%	438	0.417	0.398	0.381	0.365
Dig. Methionine	%	373	0.355	0.339	0.324	0.310
Met. + Cysteine	%	806	0.768	0.733	0.701	0.672
Dig. Met + Cys	%	685	0.653	0.623	0.596	0.571
Threonine	%	614	0.584	0.558	0.534	0.511
Dig. Threonine	%	522	0.497	0.474	0.453	0.435
Tryptophane	%	210	0.200	0.191	0.183	0.175
Dig. Tryptophane	%	179	0.170	0.163	0.155	0.149
Isoleucine	%	701	0.668	0.637	0.610	0.584
Dig. Isoleucine	%	596	0.568	0.542	0.518	0.497
Valine	%	767	0.730	0.697	0.667	0.639
Dig. Valine	%	652	0.621	0.593	0.567	0.543
Argenine	%	912	0.868	0.829	0.793	0.760
Dig. Argenine	%	775	0.738	0.704	0.674	0.646
Sodium	%	180	0.171	0.164	0.157	0.150
Potassium	%	500	0.476	0.455	0.435	0.417
Chloride min.	%	180	0.171	0.164	0.157	0.150
Chloride max.	%	310	0.295	0.282	0.270	0.258
Linoleic acid	%	1550	1.476	1.409	1.348	1.292

* The energy needs are calculated for a body weight of 1660 g. Every 50 g of change will have an impact of +/- 4 kcal / bird / day

Table 15: Nutrient requirement for a daily egg mass target of less than 51 g/hen

Nutrient						
Energy		285 – 300 kcal/hen/day 1,193 – 1,256 MJ/hen/day				
Crude protein		15.5 g/hen/day				
		mg / hen / day	105	110	115	120
Lysine	%	847	0.807	0.770	0.737	0.706
Dig. Lysine	%	720	0.686	0.655	0.626	0.600
Methionine	%	424	0.403	0.385	0.368	0.353
Dig. Methionine	%	360	0.343	0.327	0.313	0.300
Met. + Cysteine	%	779	0.742	0.708	0.678	0.649
Dig. Met + Cys	%	662	0.631	0.602	0.576	0.552
Threonine	%	593	0.565	0.539	0.516	0.494
Dig. Threonine	%	504	0.480	0.458	0.438	0.420
Tryptophane	%	203	0.194	0.185	0.177	0.169
Dig. Tryptophane	%	173	0.165	0.157	0.150	0.144
Isoleucine	%	678	0.645	0.616	0.589	0.565
Dig. Isoleucine	%	576	0.549	0.524	0.501	0.480
Valine	%	741	0.706	0.674	0.645	0.618
Dig. Valine	%	630	0.600	0.573	0.548	0.525
Argenine	%	881	0.839	0.801	0.766	0.734
Dig. Argenine	%	749	0.713	0.681	0.651	0.624
Sodium	%	180	0.171	0.164	0.157	0.150
Potassium	%	500	0.476	0.455	0.435	0.417
Chloride min.	%	180	0.171	0.164	0.157	0.150
Chloride max.	%	310	0.295	0.282	0.270	0.258
Linoleic acid	%	1550	1.476	1.409	1.348	1.292

* The energy needs are calculated for a body weight of 1660 g. Every 50 g of change will have an impact of +/- 4 kcal / bird / day

Table 16: Ca and P needs during laying period

	Before peak	Peak to 45 weeks	45 – 70 weeks	> 70 weeks
Ca (g/bird/day)	3.80	4.00	4.30	4.50
Phosphorus* (mg/bird/day)	600	540	480	430
Av. Phosphorus (mg/bird/day)	420	380	340	300
Dig. Phosphorus (mg/bird/day)	360	325	290	255

Levels can be changed based on the use and the levels of phytase

Table 17: Vitamin and trace mineral recommendation in Lay

		Lay
Vitamin A*	IU	10000
Vitamin D ₃	IU	2500
Vitamin E	IU	30 – 100
Vitamin K ₃	mg	3**
Vitamin B ₁	mg	1
Vitamin B ₂	mg	4
Vitamin B ₆	mg	3
Vitamin B ₁₂	mcg	15
Pantothenic acid	mg	10
Nicotinic acid	mg	30
Folic acid	mg	0.5
Biotin	mcg	50
Cholin	mg	400
Coccidiostat		–
Manganese	mg	100
Zinc	mg	90
Iron	mg	25
Copper	mg	10
Iodine	mg	0.5
Selenium	mg	0.3

* Higher level might be possible according to local state and national regulations.

** double in case of heat treated feed

Table 18: Addition of Coarse calcium at farm in the afternoon

Week	Grams
18 – 25	1.0
26 – 45	2.0
46 – 70	3.5
> 70	4.0

*Review the formulation to balance it in Calcium

Table 19: Particle size distribution recommendation in layer feed

Week	Fine*	Coarse**
18 – 25	35 %	65 %
26 – 45	30 %	70 %
46 – 70	25 %	75 %
> 70	15 %	85 %

*Fine Limestone: average 1 mm

**Coarse Limestone:
85 % of the particles > 3.5 mm and less than 5 % < 5 mm

Table 20: Ideal protein ratio in layer hens

	Lay
Lysine	100 %
Metethionine	50 %
Met. + Cys.	90 %
Threonine	70 %
Tryptophane	24 %
Ile	80 %
Valine	88 %
Arginine	104%

FEED STRUCTURE

Mash feed is the most commonly used feed throughout the world. Layer hens tend to eat the larger particles avoiding the fine particles which is where most of the key nutrients are. Therefore, it is vital for successful nutrition to have a uniform particle structure.

It is even more important in non-beak treated birds.

Crumble and pellet forms can be used as long as the structure holds in the feeding system of the birds and it doesn't become a fine particle mash.

KEY POINTS OF THE UNIFORMITY IN MASH DIETS

- grinding of the raw materials
- particle size of the protein sources
- addition of liquids like oil that reduces the dustiness of feed
- reduction of fine particle raw materials
- A good feed structure is even more important with non beak treated birds.
- See table 21 and 22 for guidelines

Table 21: Pullet feed particle size

Pullets	Media %
> 2 mm	28.2
> 1.4 < 2 mm	24.5
> 1 < 1.4 mm	12.8
> 0.71 < 1 mm	9.9
> 0.5 < 0.71 mm	8.8
< 0.5 mm	15.6

Table 22: Layer feed particle size

Layer	Media %
> 2 mm	26.2
> 1.4 < 2 mm	30.3
> 1 < 1.4 mm	14.4
> 0.71 < 1 mm	9.0
> 0.5 < 0.71 mm	7.1
< 0.5 mm	12.6



FEED QUALITY

Nutrients

Good information is needed to formulate a realistic diet. A combination of available literature, wet chemistry methods and/or NIR is necessary to generate an updated matrix of the raw materials we use.

Microbiology

There are no specific guidelines in place, however the lower the contamination, the better the performance parameters. Ensure adequate control measures are in place to prevent microbiological risk factors in the diet.

Oxidation

Oils in the feed mill and fat in the diet are the commonest components of oxidation. The quality control plan of raw materials should include analysis of the oxidation status of oils, evaluating at least two parameters of the available methods.

Mycotoxins

Follow the guidelines available in your country and literature to prevent negative effects on layer hen health and production. Adapt the use of mycotoxin binders to suit the level of risk in the diet and the contamination load in the raw materials.

Antinutritional Factor

Good understanding of the ANF will allow higher or lower inclusion levels of the raw materials.

Key Points

- ▶ Adjust the feed to the needs of the birds based on the body weight and egg mass produced.
- ▶ Calcium and phosphorus requirements change as the layer hen gets older. Excess and deficiencies have a negative effect in egg shell quality.
- ▶ Feed structure should be attractive for the layer hens, so they eat a complete diet.
- ▶ Thorough information of nutrient and microbiological quality is key for a good performance.



HOUSE ENVIRONMENT

- ▶ How to control the effect of temperature on the birds.
- ▶ How to provide good air quality to the birds.
- ▶ How to provide good water quality to the birds.
- ▶ How to control the effect of light on the birds.



To optimize bird performance and health we need a proper environmental control:

COLD WEATHER VENTILATION SYSTEM

Capable of bringing in small amount of fresh air during cold weather without resulting in excessive decreases in house temperature or losses in temperature uniformity:

- ▶ **Air quality control**

MODERATE WEATHER VENTILATION SYSTEM

to control house temperature during moderate times of the year

- ▶ **House temperature control**

HOT WEATHER VENTILATION SYSTEM

Capable of removing heat from the house as well as the birds.

- ▶ **Heat stress control**

HEN THERMOREGULATION

In chicks the thermoregulation starts around 4 days of age, therefore for the first 10 days of life, temperature is a critical factor because, they can't sustain an optimal body temperature without an external source of heat. For this reason, it is also important to know the way that the birds lose heat:

Convection

Heat loss occurs due to the movement of the air which permits the transfer of heat

from the hen's body to the air. This process can be promoted by providing fast air movement around the hen.

Conduction

Heat transfer from surface to surface. Normally, it is relatively unimportant as the contact surface is small and the temperature of the litter or of the cage is not significantly different from the body temperature.

Radiation

This is the transmission of heat from a warm object to a cold one. Heat loss is proportional to the temperature difference between the body surface and the surrounding air.

Evaporation

Birds use evaporation to stabilize their body temperature by increasing the respiration rate through panting, which is very effective.

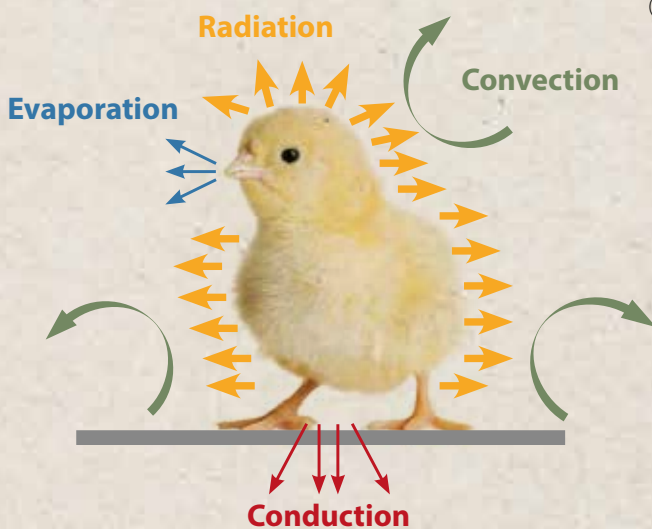

Effect of the room temperature on the different ways of losing heat

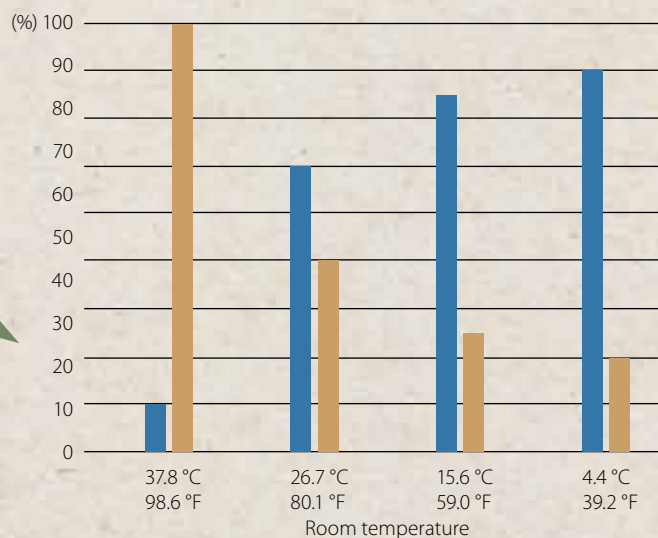

Source: Bell and Weaver, 2002

- Loss of heat by radiation, conduction and convection
- Loss of heat by respiration

HOUSE ENVIRONMENT

TEMPERATURE

The ambient temperature has a great influence on egg production. Layers perform well over a wide range of temperatures. Temperature fluctuations between 21 °C and 27 °C (69.8 °F and 80.6 °F) have a minimal effect on egg production, egg size and shell quality. Feed conversion improves with higher house temperatures, and maximum efficiency is attained in the 21–27 °C (69.8–80.6 °F) range.

As the temperature rises, however, the following parameters could be affected:

- Feed intake
- Egg weight
- Egg production
- Eggshell quality
- Mortality

A uniform temperature throughout the house is very important. Good ventilation

management and thermal insulation should help to reduce or eliminate temperature variations, specially between day and night.

The temperature should not be seen as an isolated parameter but always considered in combination with humidity. In addition, air speed is also an important element of the perceived ambient temperature.

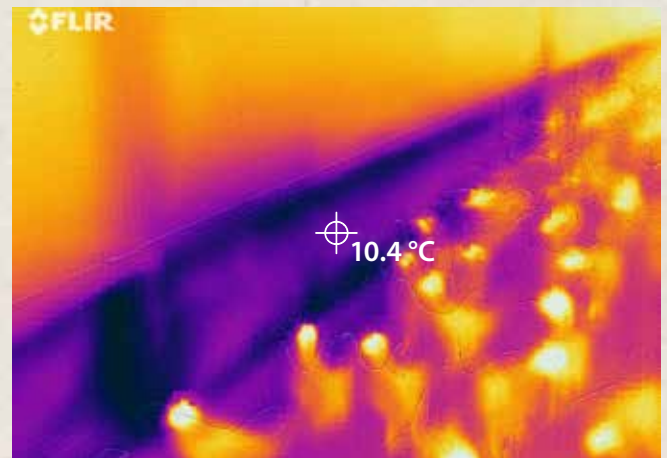

As you see in the infrared image, Pop-holes present a big challenge when trying to keep an optimal temperature and good litter characteristic in the area near them.

Table 23: Temperature and its effect on the birds

Temperature		Effects
< 20 °C	< 51.8 °F	Increased feed conversion
20–27 °C	51.8–77 °F	Ideal temperature for good performance and feed conversion.
27–31 °C	77–87.8 °F	Slightly reduced feed intake.
32–36 °C	89.6–96.8 °F	Further reduction of feed intake. Reduced activity and drop in egg production, egg weight and shell quality.
37–39 °C	98.6–102.2 °F	Severe reduction of feed intake. Increase in cracked eggs. Mortality of heavier hens or those in full production.
40–42 °C	104–107.6 °F	Severe panting and respiratory alkalosis. Increased mortality due to heat prostration.
> 42 °C	> 107.6 °F	Emergency measures are needed to cool down hens for survival.

HOUSE ENVIRONMENT

HOT CLIMATE

High temperatures, especially over a long period, can cause serious losses to the poultry farmer. The effects of heat stress are delayed onset of lay, lower performance, decreased feed intake, increased mortality and drop in the fertility. Therefore, to minimize

financial losses, every effort should be made to maintain an ambient temperature in the house that is within the bird's comfort zone. If this is not possible, corrective measure should be taken:

**Check the
Hot Climate
Management Guide**



Water Quality

When birds are heat stressed, they increase consumption of water in an effort to cool down. The ratio of water to feed increases from 2:1 under normal conditions to over 5:1 under hot conditions.

Cool water of good quality should be supplied so that birds can find relief from the heat. To ensure that all the birds have access to water, provide the minimum of water space and adjust it according to the climate conditions (see table).

During period of hot temperature, the drinker lines should be flushed every day and at least one time per day at the start of lighting program, to get fresh water into the system. Water reservoir must be insulated, light colored and shaded to keep water cool.

Ventilation

The ventilation system should be checked before the hot weather arrives. Fans should be cleaned, and fan belts should be tightened and replaced if necessary. The inlets must be adequate to supply the air flow needed, they should be clean and not obstruct the flow of the incoming air. Tunnel ventilation and cooling pads are the preferred ventilation system. Along with the ventilation system, the tightness of the house must be checked.

Excellent option is to have a high pressure fogging system in free-range houses when tunnel ventilation and cooling pads are not the best option.

Feeding Times

Do not feed at the hottest time of the day. A good strategy is to withhold feed five to eight hours prior to the anticipated time of peak temperature.

Feeder chains should be run frequently to stimulate feed intake. The feeder should remain empty no more than 2 hours during the hottest time of the day, to promote a better appetite and ensure that the fine particles are consumed, which usually consist of minerals, vitamins and amino acids. To increase feed consumption, a midnight snack can be implemented. In extreme hot climate period you can spray water on top of the feed that attract the breeders to eat! But caution must be taken to prevent and/or remove wet feed remaining in the feeder line.

Low Stocking Density

The stocking density should be in accordance with the environmental conditions. If the housing density is too high, the radiant heat between the birds will accumulate, the temperature will increase, and air will be prevented from circulating around the birds properly.

There should be enough space for the birds to separate in order to pant and droop and slightly lift their wings away from the body to maximize the heat loss.

Feed Formulation

Since feed intake is reduced during hot weather periods, the general feeding approach is to increase the energy content in the feed to keep daily energy intake at the level necessary for optimum performance under these conditions.

HOUSE ENVIRONMENT

Heat Stress

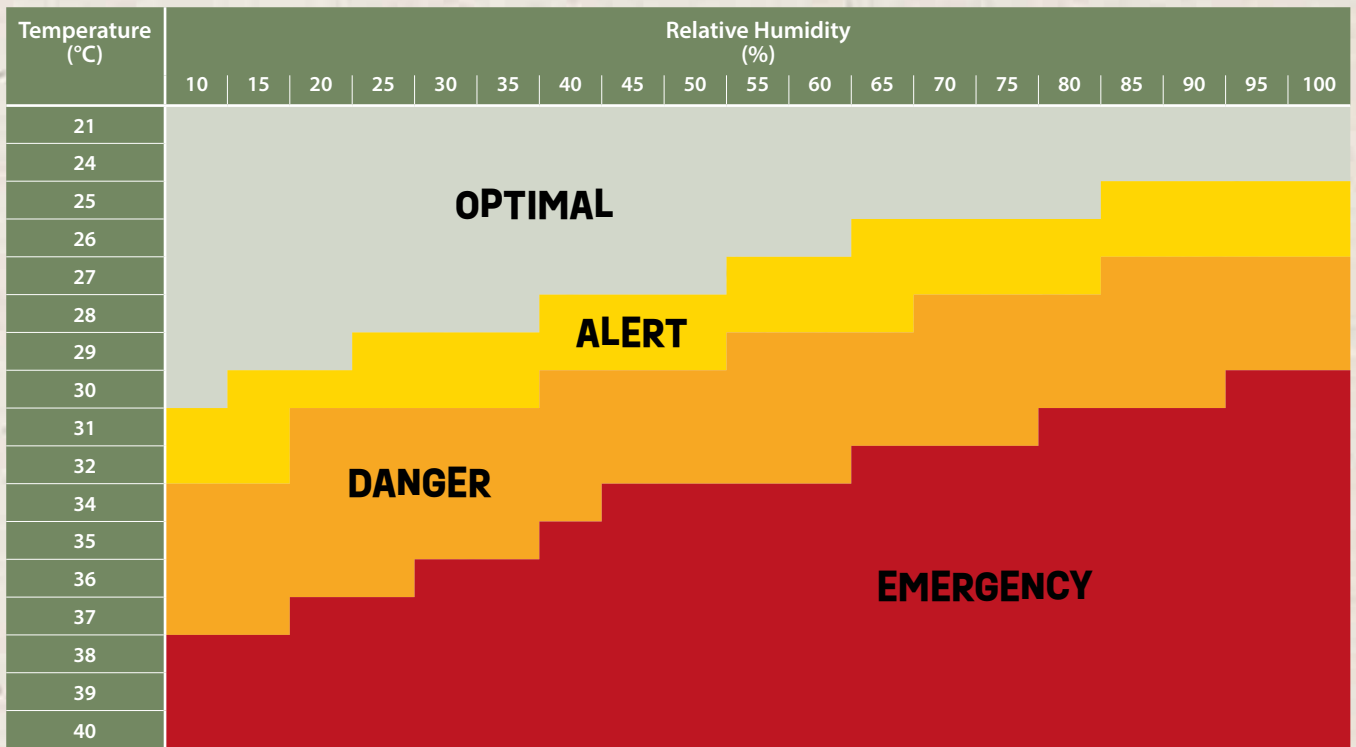

Adapted from Hongwei and Harmon, 1998

Heat Stress Index

Temperature + Relative humidity of air = Effective temperature

Heat stress index combines the effects of both temperature and relative humidity and is classified in optimal, alert, danger, and emergency.

Alert

Prepared to take necessary cooling measures; increase ventilation rate; turn on cool-

ing fans where applicable; monitor animal behaviour for signs of heat stress such as panting or open mouth; make plenty of drinking water available.

Danger

Apply additional cooling by spraying or misting the animals with water (make sure that there is plenty of air movement during this phase); start evaporative cooling pads and tunnel ventilation where applicable; When possible, move air over the animals

at a velocity in the aisle of 172 to 214 m per minute (500 to 700 ft per minute) Flush the water lines periodically. Closely monitor the animals.

Emergency

Avoid transporting market weight animals. In addition to measures listed for the Danger category, withdraw feed during the hottest part of the day; reduce light level in light-controlled houses to reduce animal activity and thus heat production.

Example of 24 hours management during heat stress conditions

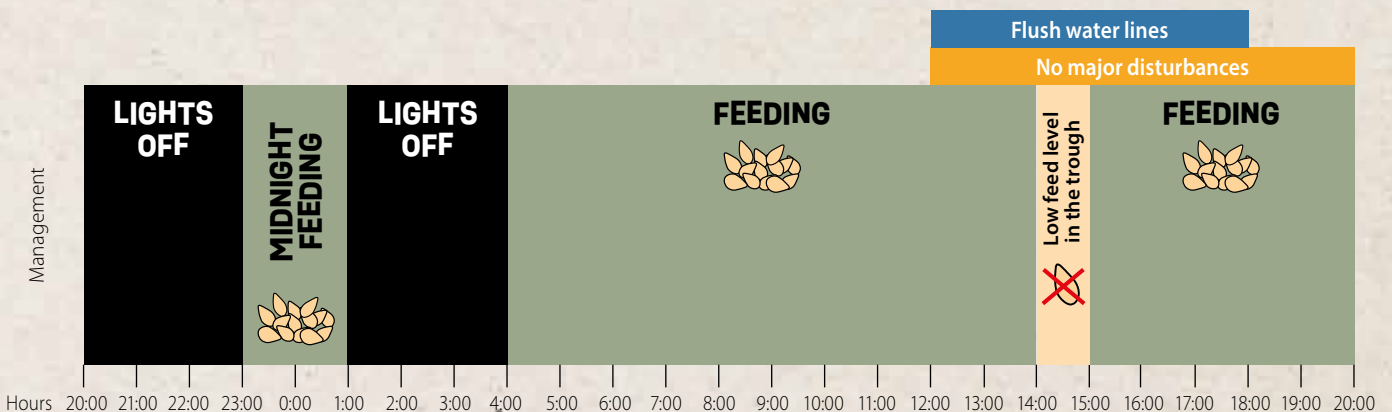

HOUSE ENVIRONMENT

VENTILATION SYSTEMS

Transverse Ventilation

1. Most commonly used during brooding or in cold weather.
2. Cold air is directed to the roof to be warmed up. Air circuit is very important for avoiding cold draft at the bird's level.
3. Important are the space between the top tier and the ceiling (at least 2 m) and the inlet design.
4. Fans should be driven on a timer, not set permanently on or off.

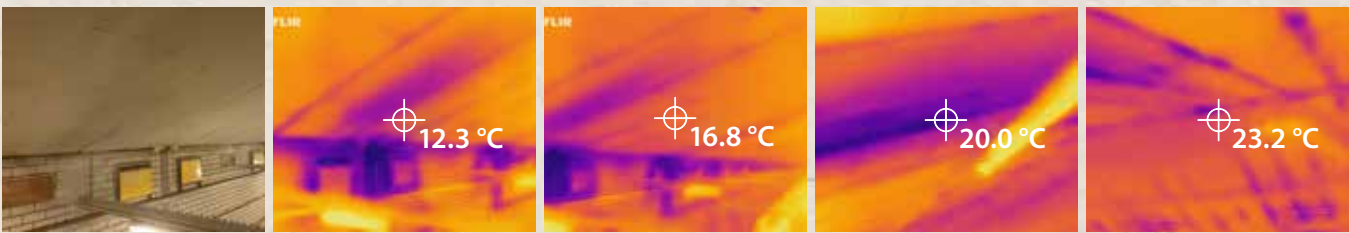
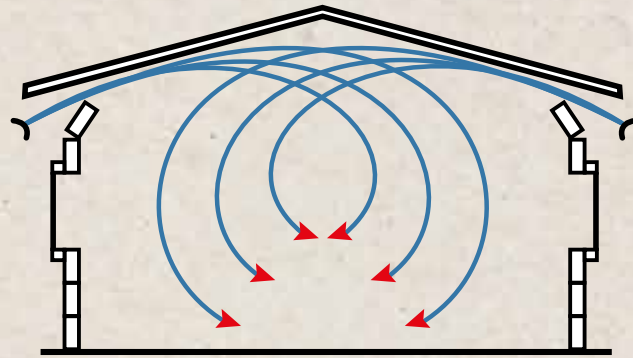

A good transverse ventilation system is intended to warm up the incoming air by directing it to the roof where the air temperature is higher. This sequence of thermal images showing us the effect of an optimal transverse ventilation

Transition System

1. Used when temperature rise but tunnel ventilation cannot be used (moderate or cold weather conditions, tunnel entrance not installed, young chicks).
2. Air is still directed to the roof.
3. Main function is to reduce the house temperature.

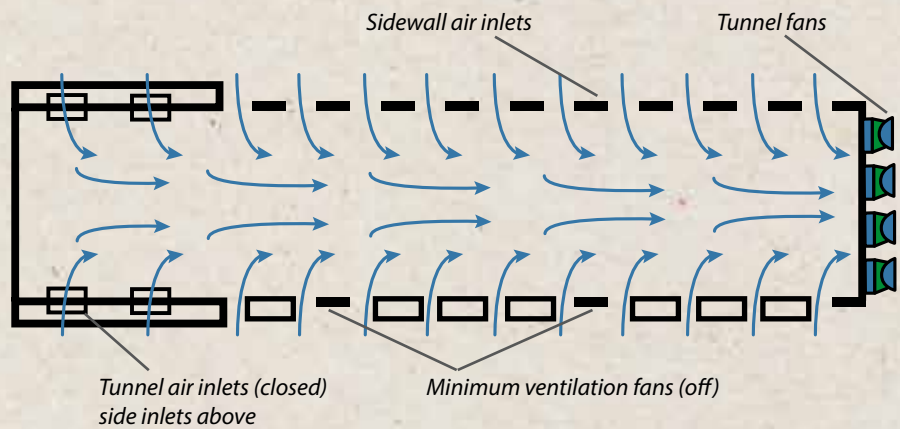

Tunnel System

1. Used in hot weathers and only in adult feathered birds.
2. It generates a high-speed flow at bird's level. It helps to cool the birds by the wind chill effect
3. Most important driver for this system is the air velocity at bird's level.
4. Best option is to install the cooling pads in a room at the front of the house

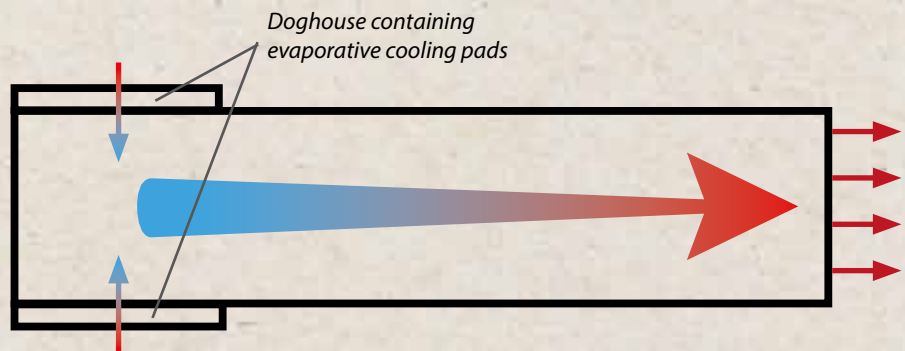

THE KEY TO ANY VENTILATION SYSTEMS BASED IN NEGATIVE PRESSURE IS THAT THE HOUSE NEEDS TO BE TIGHT, SO ALL THE AIR ENTERS THROUGH THE INLET SYSTEM DURING BOTH COLD AND HOT WEATHER.

NATURAL VENTILATION

Characteristics of natural ventilation:

1. Bring in adequate fresh air into the house. However, is difficult to control the amount entering and how it moves inside the house.
2. Depending on the external conditions.
3. An internal air distribution system will help to create and even air flow and to provide a cooling effect during hot weather.
4. Critical points are the house orientation (west to east), prevailing wind direction, roof insulation, prevent direct sun light onto the birds, among others.
5. Extremely difficult to provide the optimal conditions when outside temperature is not within the optimal range for birds. In fact, is almost impossible to control dust/ammonia, remove humidity from litter and keeping optimal temperature during

min ventilation conditions and/or cold temperatures and on the other hand cool down bird's temperature represent a huge challenge under hot and humid weather.

How to deal with large nest space in block system aviaries

- Avoid narrow aisles because make difficult to create uniform air conditions. They must be at least 2 m wide.
- Distance between the top tier and ceiling must be at least 2 m to give enough space to the incoming cold air to mix and warm up without affecting the birds.

There is always better air conditions and circulation in aviaries with wider aisles rather than narrow ones



Tips for ventilation in free-range houses

- ▶ When pop-holes are open run the house at low level of negative pressure.
- ▶ Use natural / curtain ventilation during mild weather.
- ▶ Evaporative cooling pads may not be the best option for a free-range house in hot weather. Options could be using high pressure fogging systems and / or circulation fans.
- ▶ Wide houses could be problematic (< 12 m wide)
- ▶ Negative pressure is not the only option for cold weather ventilation: positive (blowing air inside the house) or neutral pressure systems (blowing in and out air at the same time).

AIR QUALITY

Good air quality should be guaranteed in the house by using proper ventilation, so there is a low concentration of gases and dust. At the same time, the temperature in the house should be optimally maintained between 18–24 °C with a relative humidity of 40–60 %. In order to do it, you need to bring fresh air. Calculating the ventilation need is not difficult, the hardest part is to bring fresh air uniformly throughout the house without causing excessive drop in temperature or causing drafts. Therefore, the design of the inlet system is fundamental.

The rate of ventilation is determined by the temperature, however when this parameter is reached a minimum ventilation level must be guaranteed. This minimum is normally calculated in m²/body weight/hour, but the real aim is correct management of these parameters:

- Relative humidity (40 to 60 %)
- **CO₂ < 5000 ppm (critical to control)**
- CO < 50 ppm
- NH₃ < 25 ppm
- Dust concentration.

Table 24: Air Movement (m³/hour / 1000 birds)

Weeks of age	Ambient Temperature					
	32	21	10	0	-12	-13
1	360	180	130	75	75	75
3	540	270	180	136	110	110
6	1250	630	420	289	210	210
12	3000	1500	800	540	400	400
18	7140	3050	2240	1500	600	600
19+	9340–12000	5100–6800	3060–4250	1020–1700	700–1050	700–850

Circulation fans are an excellent option to create uniform conditions (temperature and air quality) between top and bottom tiers.

WATER QUALITY

Water is the most important and critical nutrient for hens. Any water privation will directly impact feed consumption and production. If privation exceed 24 hours, egg production will be severely affected. If privation exceed 48 hours, high mortality will occur in the flock. It is therefore essential to provide a good quality, stable and reliable source of water. Always prefer well water over surface water source.

Microbiological Quality

Water can act as a disease carrier if it is contaminated at the source. Moreover, a poor microbiological quality of water can affect gut health and lead to pathologic issues that affect production.

The microbiological quality at the water source must be monitored and samples should be taken at least once per year, but best is to have in place a good monitoring program. This is even more important if water comes from surface sources. The sampling program should consider not only dripping sampling but swab sampling to evaluate the biofilm presence.

Even if the water source is of excellent quality, chlorination or an alternative treatment is highly recommended. Treatment of surface water is compulsory.

Physical Quality

The content of minerals and other elements can greatly impact egg production and hen health. Even if corrective measures can be taken, it is very difficult and expensive to alter the chemical characteristics of water. A good quality water source is a huge advantage when a new farm is under construction. The physical and chemical water quality must be monitored, and samples taken at least every year.

Refusing Water

In some cases, hens can refuse water. This situation is the same as water privation:

- **Temperature:** hens will decrease their water consumption when water is above 24 °C, but will refuse it above 32 °C
- **Taste:** hens do not have a very developed sense of taste but will refuse to drink water with an unpleasant taste. Some minerals in high quantity, water additives or antibiot-



Water sanitation station

ics can produce this effect.

Every time a product is applied through the water lines you must check that the water flow isn't impaired and, after the administration always flush the water lines.

Water consumed / 1000 birds / day

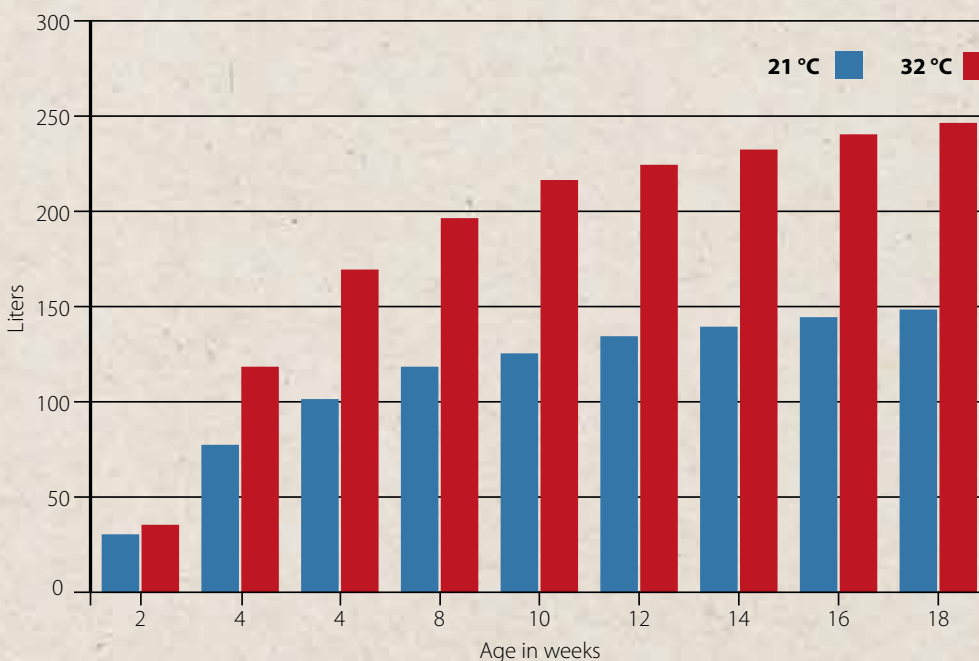

Drinking Water Parameters

Mineral	Recommended level in poultry	Effects	Treatments
Calcium	< 75 mg/l	There is no maximum limit. However, > 110 mg/l could cause scale buildup.	Same treatment as for water hardness.
Copper	< 0.6 mg/l	Its origin is probably by corrosion of pipes and joints. High levels could change the taste of water, produce oral or gizzard lesions.	
Iron	< 0.3 mg/l	Metallic taste of water, gastrointestinal disorders, decreases efficiency of vaccine and medications. Blockage of water pipes, bad smell and/or taste, encourages bacterial growth.	Treatments include the addition of some oxidant such as chlorine, chlorine dioxide or ozone then aerate and filter through an appropriate mechanical filtration process.
Magnesium	< 125 mg/l	>125 mg/l could cause wet manure due to its laxative effect. Level above 50 mg/l in conjunction with high levels of sulfate or chloride could also produce a laxative effect.	Same treatment as for water hardness.
Manganese	< 0.05 mg/l	Can be deposited in the form of black granules in filters and drinkers.	Similar to iron but can be more difficult to remove due to the slow reaction it has with chlorine. Therefore, It needs a long contact time with chlorine prior to filtration unless an iron ion exchange resin is used when pH is 6.8 or higher. The filtration should be done at a pH around 8.5. Another option is green sand filters with a pH greater than 8.0.
Nitrate	< 15 mg/l (nitrites < 1 mg/l)	Very high levels reduce the absorption of oxygen (apathetic birds, violaceous combs, and wattles), low fertility, lower feed intake, lower weight gain and production.	Reverse osmosis; ion exchange.
pH	5 – 8	Less than 5 can produce metal corrosion. Higher than 8 can affect the performance of disinfectants and the taste of water.	Organic or acid minerals to lower the pH. Basic agents to raise pH.
Phosphorus	0.1 mg/l		
Potassium	< 300 mg/l	Effects will depend on water alkalinity and pH.	
Chlorides-chlorine	< 250 mg/l	Laxative effect, wet manure, reduced feed intake and increased water consumption. Keep in mind that levels of 14 ppm can cause problems if sodium is > 50 ppm.	

HOUSE ENVIRONMENT

Mineral	Recommended level in poultry	Effects	Treatments
Sodium	50 – 300 mg/l	Together with high levels of chlorine or sulfate can cause diarrhea. In addition, it can promote the growth of Enterococci. Level > 600 mg/l could produce alterations in eggshell quality. There may be problems when lower concentrations (< 50 mg/l) are accompanied by chlorides \geq 14 ppm or sulfates > 50 ppm.	Reverse osmosis, lower dietary salt level blend with non-saline water, keep water clean and permanently use sanitizers such as hydrogen peroxide or iodine to prevent bacterial growth.
Sulfate	< 200 mg/l	Laxative effect. If high levels of magnesium and chloride or sulfate are also present (> 50 mg/l), a decrease in performance can occur. The presence of rotten egg odor can mean that there is a high concentration of hydrogen which is a byproduct of sulfate-reducing bacteria.	Aerate water in a storage tank to prevent air bubbles from entering water lines. Apply chlorine shots into the well, without stopping the normal disinfection program.
Alkalinity	< 100 mg/l	It is a value associated with bicarbonate, sulfates, and calcium carbonate. It can give a bitter taste to water which can reduce water intake and be corrosive to evaporative panels. High alkalinity levels make more difficult to lower the water pH.	Acidification (pH target < 6,5), anion exchange to reduce the water alkalinity and aeration.
Water hardness	< 150 mg/l	Water hardness can produce scale that deposit on the inner surface of pipes. Main factors are calcium and magnesium. Iron and manganese can also contribute but in lesser extent. Very high levels can also impact on medications and vaccines.	Water softeners (do not use if sodium levels are high unless potassium chloride is used instead of sodium chloride). Polyphosphates sequester the ions involved in hardness and keep them in solution. Acidify to a pH < 6,5.
Zinc	< 1.50 mg/l	Higher levels are toxic.	Filtration methods.
Fluor	< 2 mg/l	High levels can induce soft bones.	
Total dissolved solids	< 1500 ppm (< 3 weeks of age) < 3000 ppm (> 3 weeks of age)	Levels between 4000 to 7000 ppm can produce diarrhea. Concentration > 7000 ppm isn't recommended for drinking water.	Filtration methods.

HOUSE ENVIRONMENT

LIGHT

Birds vision differs from that of humans in vision spectra. Hens can see ultraviolet and infrared light. This fact should be considered when creating light programs and the light colour choice.

Hens need proper light with an adequate light intensity and the correct photoperiod. The best source of light for production is a high frequency (at least 120 Hz) bulb emitting light within the warm colour spectrum (2,500–3,500 K). Low frequency fluorescent

tubes or energy saving bulbs (50–100 Hz) have a strobe light effect on hens and encourage feather pecking and cannibalism. In addition, hens can see perfectly in a low light intensity ambience. Light intensity will vary during the different production stages but keep in mind that the higher the light intensity, the more active the hens will be. It can be positive (as in the case of brooding) or negative (as in the case of cannibalism during laying). In any case, light intensity

variation during the day should be avoided as it can cause high stress level in the hens. Direct sunlight should also be avoided for the same reason.

Light not only can be used to stimulate and keep a good production but to prevent problems (like floor eggs) and train birds to use the different equipments in cage free houses (see below pictures).

Avian Light Vision Spectrum

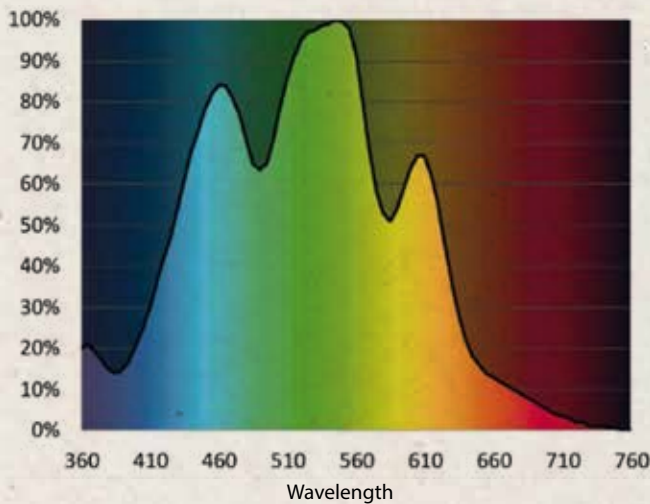

LED light to prevent floor eggs under the system



Good light distribution and intensity to reduce floor eggs



LED light to help find water line

Key Points

- ▶ Key environmental factors: air movement, air temperature and relative humidity.
- ▶ Temperature has a critical impact and must be well managed to achieve good production.
- ▶ In warm weather, take corrective measures to reduce the impact of high temperatures.
- ▶ Water is a key nutrient. Ensure that a good quality water supply is accessible to the hens.
- ▶ Maintain good air quality and distribution through correct ventilation.
- ▶ Maintain good litter quality (not too wet and not too dry).
- ▶ Remember that light has a significant effect on hen behaviour.



BIRD ASSESSMENT

► How to get reliable information to make good decisions.



PULLET PHASE

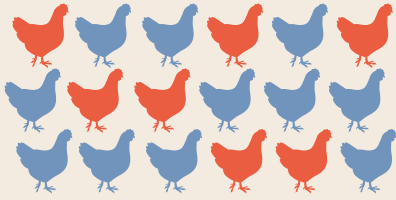

BODY WEIGHT AND UNIFORMITY



Weigh minimum 100 birds

Select cages from different tiers and also from the front, middle and back part of the house. All the birds of the selected cage need to be weighed.

Weigh weekly

Formula

$$\text{UNIFORMITY} = \frac{\text{all weighed birds} - A1 - B2}{\text{all weighed birds}}$$

A1 =

No. of birds \geq average BW x 1.1

B2 =

No. of birds \leq average BW x 0.9

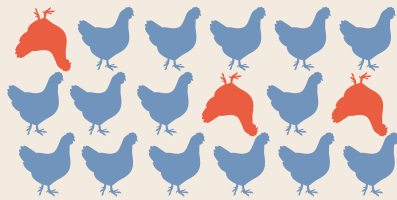

MORTALITY



Daily Mortality (%)

$$= \frac{\text{No. of dead birds today} \times 100}{\text{No. of live birds yesterday}}$$

Weekly Mortality (%)

$$= \frac{\text{No. of dead birds in last 7 days} \times 100}{\text{No. of live birds on day before the week starts}}$$

Accumulated Mortality (%)

$$= \frac{\text{No. of dead birds so far} \times 100}{\text{initial No. of housed birds}}$$

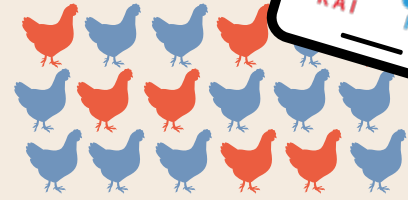

SHANK LENGTH OR KEEL LENGTH



Measure minimum 50 birds

All the birds of the selected cage or area need to be measured.

Measure 5th week before transfer

How to do shank measurements



How to do keel measurements



LAYING HENS

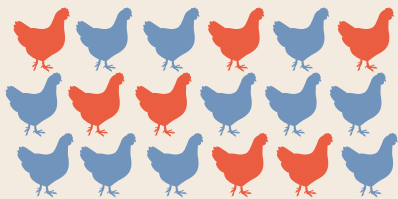

BODY WEIGHT AND UNIFORMITY



Weigh minimum 100 birds

Select cages from different tiers and also from the front, middle and back part of the house.

All the birds of the selected cage need to be weighed.

Frequency

Weigh weekly up to 30 weeks of age

Weigh every 2 weeks up to 40 weeks of age

Weigh monthly after 40 weeks of age

Formula

$$\text{UNIFORMITY} = \frac{\text{all weighed birds} - A1 - B2}{\text{all weighed birds}}$$

A1 =

No. of birds \geq average BW x 1.1

B2 =

No. of birds \leq average BW x 0.9

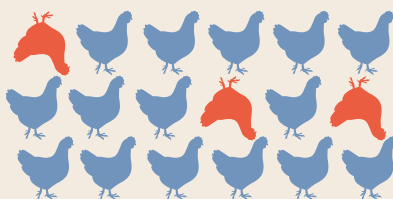

MORTALITY



Daily Mortality (%)

$$= \frac{\text{No. of dead birds today} \times 100}{\text{No. of live birds yesterday}}$$

Weekly Mortality (%)

$$= \frac{\text{No. of dead birds in last 7 days} \times 100}{\text{No. of live birds on day before the week starts}}$$

Accumulated Mortality (%)

$$= \frac{\text{No. of dead birds so far} \times 100}{\text{initial No. of housed birds}}$$

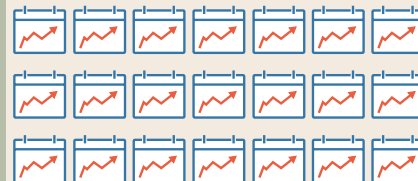

EFFICIENCY PARAMETERS



FCR kg/kg

$$= \frac{\text{kg of feed consumed}}{\text{kg of eggs produced}} \quad (\text{No. of eggs} \times \text{average egg weight})$$

FCR kg/egg

$$= \frac{\text{kg of feed consumed}}{\text{No. of eggs}}$$

Egg per Hen Housed

$$= \frac{\text{No. of eggs produced}}{\text{No. of hens in the production house after the transfer}}$$

FCR kg/12 eggs

$$= \frac{\text{kg of feed consumed} \times 12}{\text{No. of total eggs produced}}$$

IOFC

$$= \frac{\text{egg mass hen housed} \times 0.8}{\text{feed intake per hen housed} \times 0.2}$$

LAYING HENS

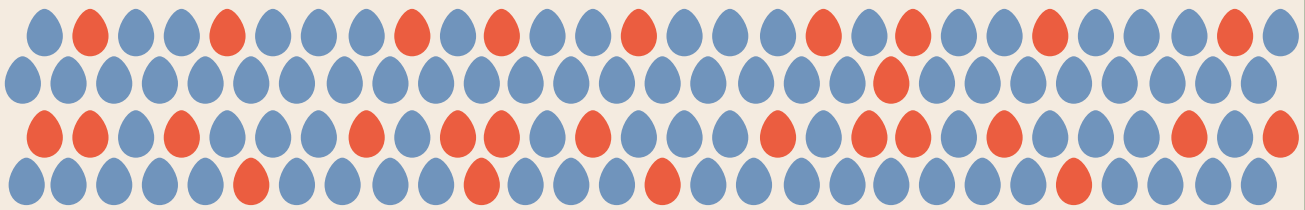

EGG PRODUCTION

Daily Laying Rate (%)

$$= \frac{\text{all produced eggs} \times 100}{\text{daily birds in the farm}}$$

Weekly Lay (%)

$$= \frac{\text{Sum of all produced eggs within 7 days} \times 100}{\text{Sum of all the birds within 7 days}}$$

Accumulated Lay (%)

$$= \frac{\text{Sum of all the produced eggs}}{\text{No. of birds housed} \times \text{Days in production}}$$

Daily egg size

$$= \frac{\text{Total weight of produced eggs}}{\text{Total No. of produced eggs}}$$

Weekly egg size

$$= \text{Average egg size of the last 7 days}$$

Accumulated egg size (g)

$$= \text{Average of the weight of all produced eggs}$$

Daily egg mass

$$= \frac{\text{Daily \% lay} \times \text{Daily egg size}}{100}$$

Weekly egg mass

$$= \frac{\text{Weekly \% lay} \times \text{Weekly egg size}}{100}$$

Accumulated egg mass

$$= \frac{\text{Produced eggs} \times \text{Egg weight}}{\text{No. of birds housed}}$$

Under grade

1. No. of broken eggs (BE)
2. No. of cracked eggs (FE)
3. No. of dirty eggs (DE)

Daily Under grade (%)

$$= \frac{\text{No. of daily BE, FE, DE} \times 100}{\text{No. of all daily eggs}}$$

Accumulated Under grade

$$= \frac{\text{No. of all BE, FE, DE so far} \times 100}{\text{No. of all eggs so far}}$$

HEALTH & BIOSECURITY

- ▶ Understanding the importance of health programs in modern egg production.
- ▶ How to implement a biosecurity program.
- ▶ How to implement and monitor a vaccination program.

WHAT IS A HEALTHY HEN?

Knowing a hen's health status is essential to achieve production goals. Sick birds cannot develop to their full genetic potential so health programs play a central role in the production schedule.

Healthy hens are disease-free or, at least, can support and deal with the diseases that are present in their environment. Biosecurity is

key to keeping the flock free of pathogen agents or, at least, reducing their presence. Flock immunity is the corner stone that prepares hens to handle the threat of disease. This relates not only to the vaccination program but also to the hen's physical status. If hens are immuno-suppressed due to under-feeding, stress or other reasons (mycotoxins,

chemicals) it will be difficult to cope with diseases even if the hens have been vaccinated. Certain avian diseases (such as Salmonella enteritis or Campylobacter) are zoonoses which can spread between birds and humans. So even if a disease does not directly affect poultry, it should be included the health program.

Healthy Hens



- ▶ No respiratory signs
- ▶ No nervous signs
- ▶ No fever



- ▶ Good physical status
- ▶ Good bone calcification
- ▶ Good feathering status



- ▶ Alert and active birds
- ▶ No abnormal behaviour



- ▶ Good production
- ▶ No abnormal eggs

Possible Infection Routes

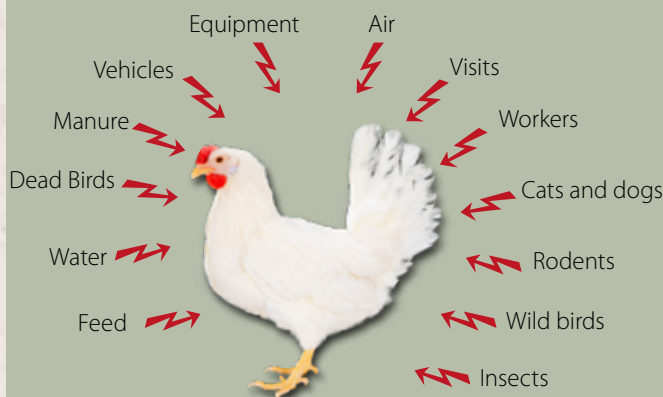

Health Balance

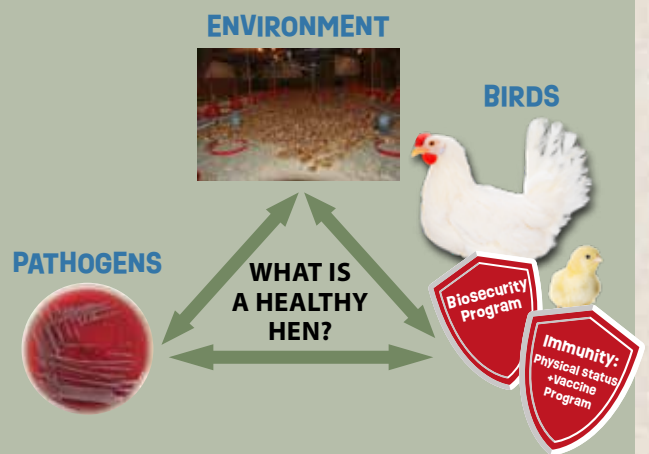

BIOSECURITY PROGRAM

A biosecurity program plays a key role in maintaining hens in good health and, therefore, profitable production. Biosecurity can be defined as all the procedures put in place to prevent pathogens infecting hens and spreading to other poultry farms. To be effective, a biosecurity program

should be implemented in a very practical and structured way. An effective biosecurity program is well-adapted to the production structures and well-understood by all the actors (staff, production managers, external suppliers, veterinarians, general manager etc.) at the farm. If certain actors do not take

biosecurity seriously and fail to follow the procedures, the efforts of the others will not be rewarded.

It is essential to apply procedures systematically. Sporadic application of a biosecurity program will not work.

BIOSECURITY TYPES

Conceptual Biosecurity

► This is the biosecurity related to the farm design and its location of the farm and its surroundings.

Ideally farms should be situated away from:

- other poultry farms (including backyard farms)
- other farms (other species)
- Live bird markets
- Hatcheries
- Slaughterhouses

If these kind of facilities are near to the farm, structural and operational biosecurity should be improved. If possible, new farms should be constructed in biosecure locations.



Isolated location



High-density farm location

Structural Biosecurity

► This is the biosecurity related to the physical structures used at the farm to prevent the introduction or spread of diseases.

Important components include:

- Perimeter fences
- Surrounding buffer zone
- Bird-proof elements
- Entrance doors
- Disinfectant system in entrance door
- Shower or black/white room
- Booth baths
- Work clothing and footwear
- Feed storehouse or silos
- Dead bird disposal



Sink



Surrounding concrete zone

Operational Biosecurity

► This is the biosecurity related to how work on the farm should be done to prevent the introduction or spread of diseases.

People are the key element to success here. Good communication, which implies training, is essential to improve operational biosecurity.

Clear and written biosecurity protocol should be available for all the staff having contact with the farms. Normally the simplest rules work better than the complicated.

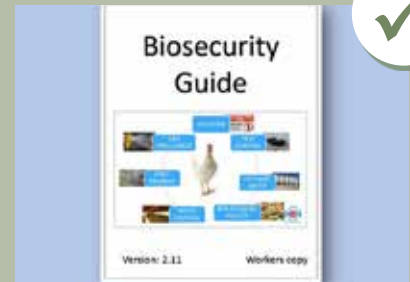

Written biosecurity protocol



Farm meeting room

BIOSECURITY PROGRAM – STEP 1

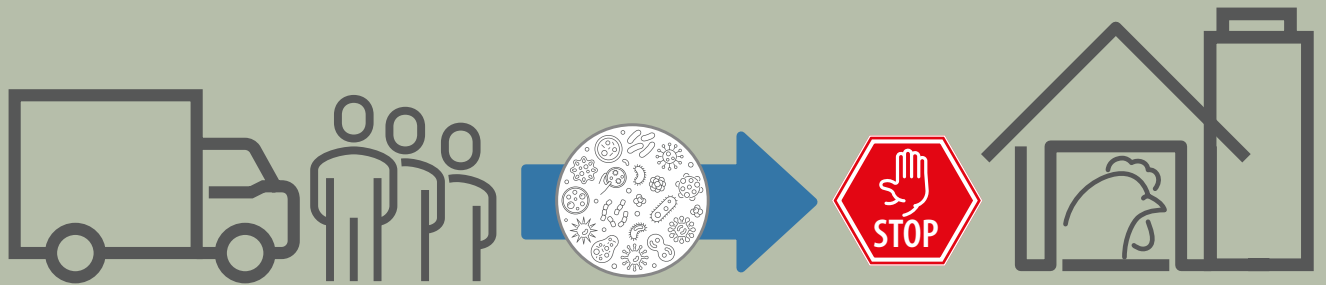

ISOLATION

► This includes all measures taken to prevent the introduction of pathogens by visitors or material entering the farm.

Some basic rules:

Visit Restriction

Only essential visits with a clear purpose should be permitted. All visits/visitors should be considered as a risk for the flock.

Visitor Register

A logbook should be available for visitors. All visitors must fill in their name, date of visit, purpose of visit, last visited farm and vehicle license number.

Visitor Policy

Visitors coming from another external farm on the same day must not be permitted entry. Visitors from sites of a disease out-break are absolutely forbidden entry. If several company farms are visited on the same day, the sequence must be from younger flocks to older ones.

Work Clothing

Specific work clothing must be available for staff and visitors.

Vehicle Disinfection

Vehicles must be disinfected prior to their entry to the farm. If vehicle access to the farm is not a necessity, preferably park vehicles outside the farm.

Material / Equipment Disinfection

All material must be disinfected prior to entry to the farm. This is even more important if the material comes from another farm.



Closed gate with biosecurity signs



Visitor register



Farm clothes and shoes



Disinfection tunnel for vehicles



Showers



On farm washing machine and clothes dryer

BIOSECURITY PROGRAM – STEP 2

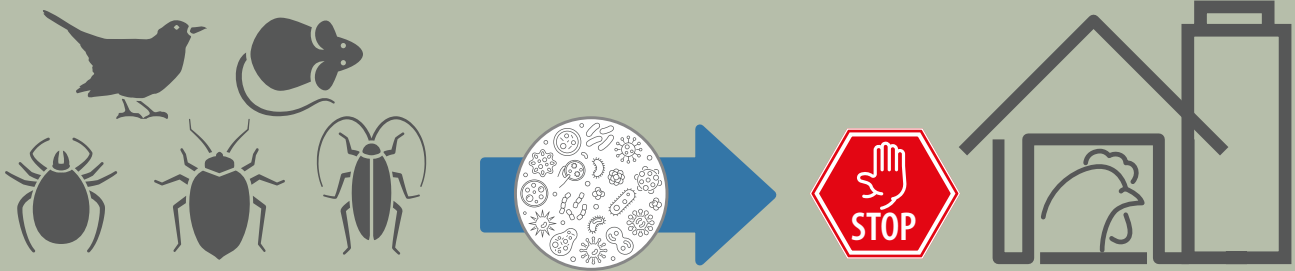

PEST CONTROL

► This includes all measures taken to prevent the introduction and spread of pathogens by vermin (esp. rodents and birds) and insects.

Rodents

The flock health status will be severely damaged in the event of infestations of rats or mice.

Passive measures:

- Keep the perimeter around the house free of grass and other organic material.
- Maintain integrity of walls.
- Keep feed free of rodents.
- Remove any spilled feed.

Active measures:

- Install bait stations.
- Have an active Rodent Control Program.

Birds

It is very important to exclude other birds from entering hen houses. Bird-proof houses can be constructed using special netting. Bird's feces are also very infectious material. Direct or indirect contact should be completely avoided.

Insects and other

Establish an insecticide program. Manure management is also very important to prevent flies.

Mites can be very damaging to the hens overall health status. This is particularly the case with Red Mite and Northern Fowl Mite. See its control in the Technical Tips.



BIOSECURITY PROGRAM – STEP 3

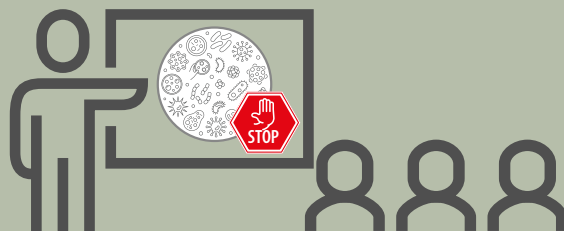

STAFF TRAINING

► This includes all measures related to training workers to do their jobs properly and observe biosecurity regulations.

Information, meetings and training days should be provided to staff and other people working on the farm to ensure that they

understand, respect and collaborate in the biosecurity program. It is also very important to ensure staff do

not raise poultry at home or come into contact with other birds (pigeons, hawks, ducks, ...).

BIOSECURITY PROGRAM – STEP 4

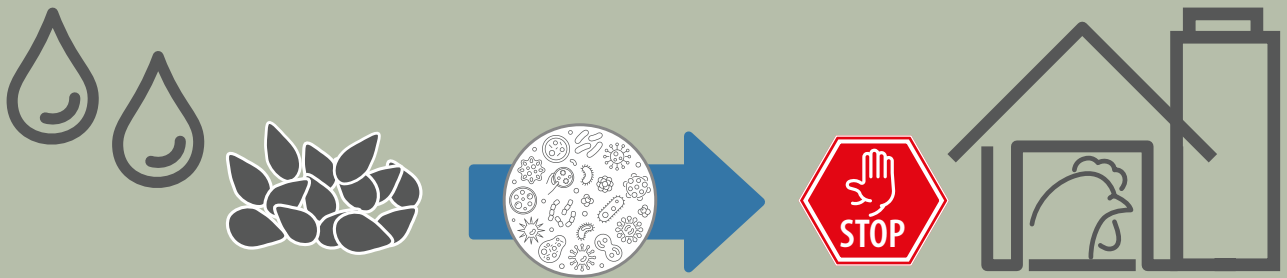

FEED & WATER

► This includes all measures taken to avoid the introduction and spread of pathogens by water and feed.

Feed

The quality of raw materials and hygiene measures at the feed mill are vital to produce pathogen-free feed.

Adding disinfectants is also recommended. Feed transport and feed storage should be controlled to avoid contamination after feed mill delivery.

Water

Chlorine or an alternative disinfectant should be added to drinking water. It has a dual purpose: firstly preventing the introduction of pathogens by water and secondly reducing water recontamination while it is in the house pipeline.

See page 54 for more information on water quality.



Silos in good conditions



BIOSECURITY PROGRAM – STEP 5

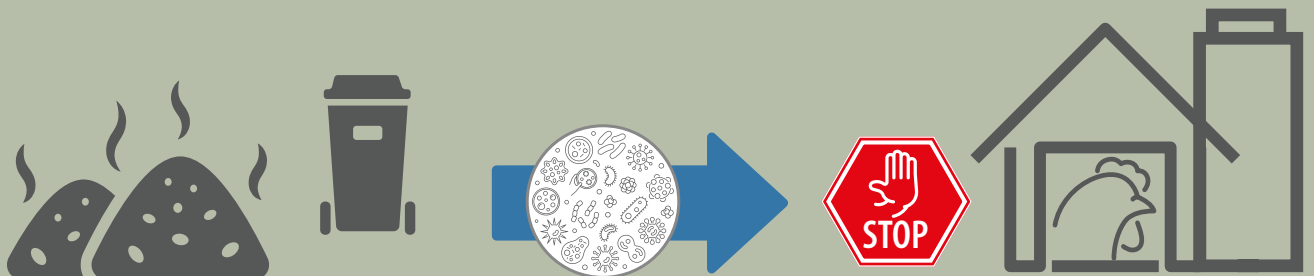

WASTE DISPOSAL

► This includes all measures to prevent the introduction of pathogens during waste removal.

Waste removal and disposal is critical because waste material can be heavily contaminated.

Manure

Manure should be removed and disposed of at least 3 km away from the site. Make sure that no other farms dispose of their manure within a 3 km radius of your farm.

Dead Birds

Dead birds should be removed from hous-

es on a daily basis and stored away from the poultry houses.

Different methods are available to destroy the dead birds hygienically. If dead birds are moved from the farm, take extreme care during transport:

- Never permit transport of dead birds to enter the farm.
- Only permit dead birds to be collected outside the farm.
- Never have personal contact with people handling dead birds.



Dead birds container



BIOSECURITY PROGRAM – STEP 6



CLEANING & DISINFECTION PROTOCOL

► This includes all measures to prevent pathogens being transferred from one flock to the following.

If a severe infestation of mites or other parasites has occurred, take extra precautionary measures to eliminate or exclude the presence of pests. See more details about the procedure in page 6 and 7.

Table 25: Common disinfectants used in farms

Chemical disinfectant	Mycoplasma	Gram + Bacteria	Gram – Bacteria	Enveloped virus	Non-enveloped virus	Fungal spores	Coccidia	Characteristic
Aldehydes	++	++	++	++	++	+	–	Efficacy reduced by organic material, soap and hard water. Irritative
Alkalis	++	+	+	+	+–	+	+	Corrosive, irritative
Biguanides	++	++	++	+–	–	–	–	Ph dependent, inactivated by soaps
Chlorine Compounds	++	++	+	+	+–	+	–	Inactivated by sunlight and soap, corrosive, irritative
Oxidant agents	++	+	+	+	+–	+–	–	Corrosive
Phenolic Compounds	++	+	++	+–	–	+	+–	Irritative
Quaternary Ammonium Compounds	+	+	+	+–	–	+–	–	Inactivated by organic material, soap and hard water

BIOSECURITY PROGRAM – STEP 7

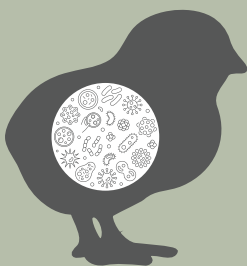

PULLET REPLACEMENT

► This includes all measures to prevent the introduction of vertically transmitted pathogens.

In order to achieve this, the breeder flock should remain disease-free. Sampling and analysis should be encouraged to check that one-day old chicks are not contaminated. H&N grandparent stock are free of lym-

phoid leukosis, *Mycoplasma gallisepticum*, *Mycoplasma synoviae*, *Salmonella pullorum*, *Salmonella gallinarum*, *Salmonella enteritidis*, *Salmonella thyphimurium* and other *Salmonella* species.

Take into account that transport crates, trucks and other equipment can be infected with pathogens or infested with parasites. Previous cleaning and disinfection of all of them is strongly recommended.

VACCINATION PROGRAMS

Specific recommendations for individual farms are not possible, but the sample vaccination program (table 26) is intended as a very general guideline for vaccinations which are needed on most farms worldwide.

Additional vaccinations for coccidiosis, Escherichia coli, Avian Influenza and the variant strains of other disease-causing agents may also be needed. These decisions, however, need to be made on a farm-by-farm basis after careful consideration of the risk factors involved which

include, but are not limited to: previous exposure, geographic location, vaccination and exposure of neighboring flocks, state regulations and endemic disease-causing factors.

Ask for an adapted vaccine program from your local veterinarian.

Table 26: Vaccination program

Weeks	Marek Disease	Infectious Bronchitis	Gumboro Disease	Gumboro Disease (vectored vaccine)	Metapneumovirus Avian	Newcastle Disease	Newcastle Disease (high challenge)	Newcastle Disease (high challenge, vector vaccine)	EDS 76	Lariongotracheitis	Laringoracheitis (vectored vaccine)	Fowl Pox	Encephalomyelitis	Coccidia*	Coryza	Fowl Cholera	Escherichia coli	Salmonella enteritidis **
0	1 SC	1 SP		1 SC		1 SP	1 SP 2 IM	1 SP 1 SC			1 SC			1 SP				1 DW
1																		
2			1 DW			1 SP/ DW	1 SP/ DW	1 SP/ DW										
3			2 DW															
4		2 SP	3 DW															
5																		
6						2 SP/ DW	2 SP/ DW	2 SP/ DW										1 DW
7					1 SP/ DW									1 IM	1 IM	1 IM		
8										1 ED		1 WI	1 WI					
9		3 SP																
10						3 SP/ DW	3 SP/ DW	3 SP/ DW										
11																		
12																		1 DW
13															1 IM	1 IM	1 IM	
14																		
15		1 IM			1 IM	1 IM	1 IM	1 IM	1 IM									
16																		

SC = Subcutaneous Injection
IM = Intramuscular Injection
ED = Eye Drop

SP = Spray
DW = Drinking Water
WI = Wing Inoculation

Inactivated vaccines Live vaccines Recombinant vaccines

* Preferably attenuated vaccines

** Salmonella vaccination program must be adapted to comply with national legislation.

ADMINISTERING VACCINES IN PRACTICE

Administering the vaccines in practice is just as important as the vaccine program design. All this involves is simply following a proce-

cedure that is clearly defined by the vaccine manufacturer. However, mistakes are still often made. To avoid errors, check and audit

these procedures regularly. Proper vaccination is essential for a good health status.

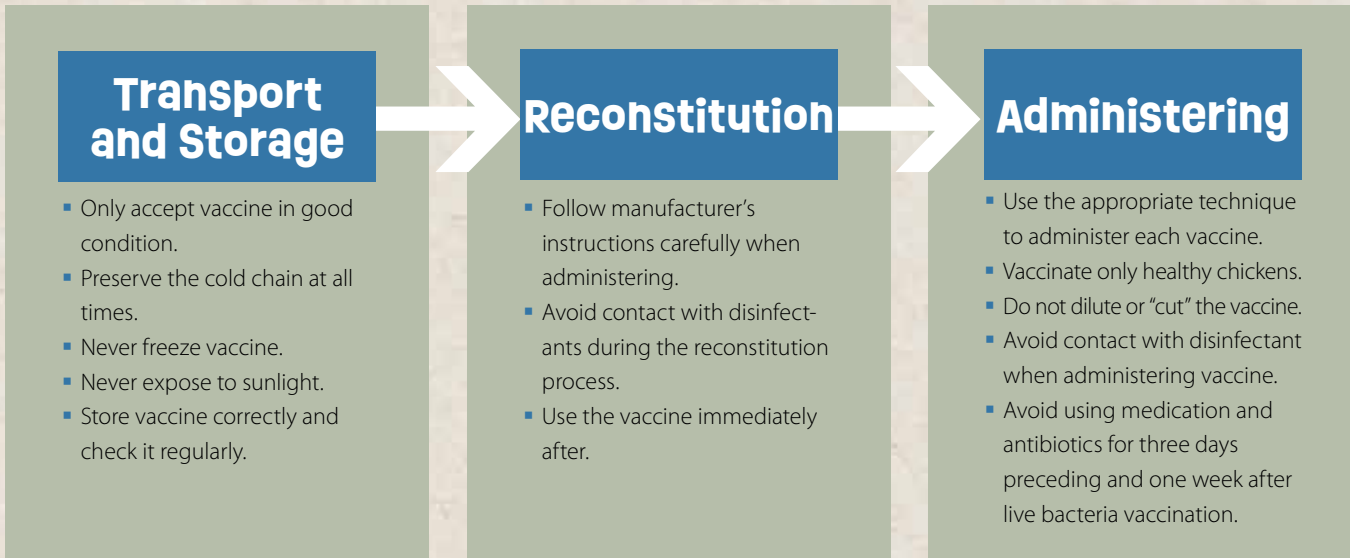

Mass Administration

Drinking Water

- Most common vaccination technique.
- Assure the absence of chlorine or other disinfectant in the drinking water.
- A previous water privation can assure that all birds are thirsty.
- Use dye in the drinking water for monitoring water consumption.
- Assure that water is consumed within 2 hours.

Spray

- Used for respiratory disease vaccination.
- Assure the absence of chlorine or other disinfectant in the sprayed water.
- Droplet size plays a key role in the vaccine reactions and immune response.
- Distribute vaccine homogeneously among the birds.
- Avoid drafts during the vaccine administration.

Individual Administration

Eye Drop

- Used for respiratory disease vaccination.
- Use dye in order to assess the efficiency of instillation.
- Trained and committed crew and a well organised program of work is essential.
- Ensure all chick's are vaccinated.

Injection

- Used for inactivated vaccines and certain live vaccines.
- Injection can be subcutaneous or intramuscular depending on the vaccine.
- Equipment should be correctly maintained.
- Trained and committed crew along with a well organised program of work is essential.

Wing Inoculation

- Used mostly for Pox vaccination.
- Assure that needle is in contact with the vaccine before you inoculate every individual bird.
- Trained and committed crew and a well organised program of work is essential.
- Check vaccine reaction 7 days after administering it in the case of Pox vaccine. More than 90 % of chicks should be positive.

VACCINE MONITORING

Serological data obtained after the bulk of the vaccination program is completed, normally by 15 or 16 weeks of age is a good method for evaluating the immune status of a flock of pullets prior to production. Such data also serves as an immune status baseline for determining whether a field infection has occurred when production drops

are observed. It is recommended that the flock owner submits 25 good serum samples to a laboratory one or two weeks prior to the pullets being placed in the laying house to establish freedom from certain diseases such as *Mycoplasma gallisepticum* (Mg) and *Mycoplasma synoviae* (Ms) prior to onset of production.

Serological data can give valuable information on the serological titer levels for a number of disease-causing agents. Working with a poultry laboratory to set up a profiling system will make better evaluations of vaccination programs and flock conditions possible.

Table 27: Serological monitoring

Disease	ND	IB	AmPV	EDS	AE	MG	MS	IBD
Technique	ELISA, HAI	ELISA, HAI	ELISA	ELISA	ELISA	ELISA, PRA	ELISA, PRA	ELISA
Week	15, 25, 45, 65, 85	15, 25, 45, 65, 85	15, 25, 45, 65, 85	15, 25, 45, 65, 85	15, 25	1, 15, 25, 45, 65, 85	1, 15, 25, 45, 65, 85	1

COCCIDIA

Coccidiosis is a disease caused by protozoan species of the genus *Eimeria*. They are species-specific and those affecting hens replicate in different parts of the intestine. The severity of the disease produced depends on the species and the degree of infestation. In some cases, the bird will die, while in others the birds will be stunted in their growth and are likely to have complications with necrotic enteritis.

In long-lived birds, control is based on the establishment of immunity against each of the *Eimeria* species. Cross immunity is very poor and does not provide good protection. For this purpose, chemical control programs can be used as long as they allow partial cycling of the protozoa. In this way, lesions are reduced but immunity can be developed if there is a challenge during rearing. Another simpler and more effective option

is the use of vaccines. These are usually given in the first few days of life and must be cycled several times in the birds to produce a long-lasting and robust immunity. For this, not only their application but also the management of the birds in these early weeks must be well monitored. It should be noted that management is different depending on the type of vaccine used (attenuated or non-attenuated).

Lesion location in the gut for main *Eimeria* species in chickens

Eimeria acervulina



Eimeria maxima



Eimeria necatrix



Eimeria brunetti



Eimeria tenella



INTERNAL PARASITES

Internal parasites are a common finding in birds in free-range systems but may also be present when birds do not have access to outdoor parks.

They cause a reduction in nutrient absorption by the birds. Depending on the level of infestation this can lead to a deterioration in bird body condition, decreases in production, egg quality and even promote cannibalism and mortality.

They usually cycle outside the bird's gut which may be direct or have another intermediate host. Different species also colonize different parts of the intestine or other parts of the bird's body.

Since it is very difficult to avoid contact with these parasites (especially in free-range), a population control program should be applied to avoid heavy infestations that cause damage to the birds.

- In those parasites that have cycles with an intermediate host, it is important to cut the cycle by controlling the population of these hosts.
- Rotation of outdoor flocks as well as proper drainage and maintenance are necessary to avoid areas with high egg loads.
- N&D programs should include treatments to reduce the parasite egg load during the service period.
- It is necessary to monitor the presence of parasites either by faecal egg counts or by post mortem examinations.
- Flocks should be treated with deworming drugs repeatedly to keep parasite populations from growing out of control and minimise the damage caused.

The main parasites found in laying hens

Hair Worm (*Capillaria*)



These nematodes (worms) parasitize the small intestine. They are small in size: males usually measure 7–13 mm while females are 10–18 mm, so they are difficult to visualize. Some species have the earthworm as an intermediate host.

Cecal Worm (*Heterakis gallinarum*)



These nematodes (worms) are usually found in the cecum. They are tiny: males are about 7–10 mm long while females are about 10–15 mm. They have a direct cycle, but earthworms can act as carrier for them. They are not usually harmful in themselves but because play a critical role as *Histomonas meleagridis* carrier.

Round Worm (*Ascaridia galli*)



This the most common infestation. These nematodes (worms) parasitize the small intestine although occasionally they can reach other organs. Occasionally found in eggs. Adults are large, thick, yellowish white worms. Male is 5–7 cm long and female is 6–12 cm, so they can be easily observed during autopsies or in feces. They have a direct cycle, but insect can play a role in their spread as carriers.

Tapeworm (*Amoebtaenia, Davainea, Raillietina ...*)



Various species of cestodes can parasitise long-living poultry. They do not normally cause damage except in the case of heavy infestations. They usually have cycles with intermediate hosts (ants, houseflies, beetles, snails, ...).

Key Points

- ▶ Health is vital to achieve the bird's full genetic potential.
Act before diseases become a limiting factor for your birds performance!
- ▶ Implement a real biosecurity program, not a paper biosecurity program.
- ▶ Adapt the vaccine program to your epidemiological situation.
- ▶ Administer vaccines according to the manufacturers' instructions.
No vaccine program will work if vaccines are administered incorrectly.
- ▶ Monitor flock serology to verify the effectiveness of your vaccination program.
- ▶ Internal parasite control should be considered to avoid damage produced by heavy infestation.



PERFORMANCE GOALS

Table 28: Performance of the H&N “Super Nick” layer to 100 weeks of age under good management and moderate environment

Age week	Liveability %	Prod. HD %	Eggs/HH eggs	Egg Weight g/egg	Cum. Egg Weight g/egg	Egg Mass kg	Body Weight g
19	100.0	10.0	0.7	44.4	44.4	0.03	1393
20	100.0	38.2	3.4	47.5	46.9	0.16	1448
21	99.9	59.2	7.5	50.0	48.6	0.37	1496
22	99.9	74.2	12.7	52.0	50.0	0.63	1537
23	99.8	84.2	18.6	53.6	51.1	0.95	1571
24	99.8	89.5	24.8	54.9	52.1	1.29	1599
25	99.7	91.4	31.2	56.0	52.9	1.65	1621
26	99.7	92.3	37.7	56.9	53.6	2.02	1637
27	99.6	92.9	44.1	57.7	54.2	2.39	1648
28	99.6	93.3	50.6	58.4	54.7	2.77	1654
29	99.5	93.6	57.2	59.0	55.2	3.16	1658
30	99.5	93.8	63.7	59.6	55.7	3.54	1661
31	99.4	94.0	70.2	60.1	56.1	3.94	1664
32	99.4	94.1	76.8	60.5	56.4	4.33	1667
33	99.4	94.2	83.3	60.9	56.8	4.73	1670
34	99.3	94.3	89.9	61.2	57.1	5.13	1673
35	99.3	94.3	96.4	61.5	57.4	5.54	1676
36	99.2	94.3	103.0	61.8	57.7	5.94	1679
37	99.1	94.3	109.5	62.0	58.0	6.35	1682
38	99.1	94.3	116.1	62.1	58.2	6.75	1685
39	99.0	94.3	122.6	62.2	58.4	7.16	1688
40	98.9	94.3	129.1	62.4	58.6	7.57	1691
41	98.8	94.3	135.7	62.5	58.8	7.98	1694
42	98.7	94.2	142.2	62.7	59.0	8.38	1697
43	98.6	94.1	148.7	62.8	59.1	8.79	1700
44	98.5	94.0	155.1	62.9	59.3	9.20	1703
45	98.4	93.9	161.6	63.0	59.4	9.61	1706
46	98.3	93.8	168.1	63.1	59.6	10.01	1708
47	98.2	93.7	174.5	63.3	59.7	10.42	1710
48	98.2	93.6	180.9	63.4	59.9	10.83	1712
49	98.1	93.4	187.4	63.5	60.0	11.24	1714
50	98.0	93.2	193.7	63.6	60.1	11.64	1716
51	97.9	93.0	200.1	63.7	60.2	12.05	1718
52	97.8	92.8	206.5	63.8	60.3	12.45	1720
53	97.7	92.6	212.8	63.9	60.4	12.86	1722
54	97.5	92.4	219.1	64.0	60.5	13.26	1724
55	97.4	92.1	225.4	64.1	60.6	13.67	1726
56	97.3	91.8	231.6	64.2	60.7	14.07	1728
57	97.2	91.5	237.9	64.3	60.8	14.47	1730
58	97.0	91.2	244.1	64.4	60.9	14.87	1732
59	97.0	90.9	250.2	64.5	61.0	15.26	1734
60	96.9	90.6	256.4	64.5	61.1	15.66	1736

PERFORMANCE GOALS

Table 28: Performance of the H&N “Super Nick” layer to 100 weeks of age under good management and moderate environment

Age week	Liveability %	Prod. HD %	Eggs/HH eggs	Egg Weight g/egg	Cum. Egg Weight g/egg	Egg Mass kg	Body Weight g
61	96.7	90.3	262.5	64.6	61.2	16.06	1738
62	96.6	89.9	268.6	64.6	61.2	16.45	1740
63	96.4	89.5	274.6	64.7	61.3	16.84	1742
64	96.3	89.1	280.6	64.8	61.4	17.23	1744
65	96.1	88.7	286.6	64.9	61.5	17.62	1746
66	96.0	88.3	292.5	64.9	61.5	18.00	1748
67	95.8	87.9	298.4	65.0	61.6	18.38	1750
68	95.7	87.5	304.3	65.1	61.7	18.77	1752
69	95.6	87.0	310.1	65.2	61.7	19.14	1754
70	95.5	86.5	315.9	65.2	61.8	19.52	1756
71	95.3	86.0	321.6	65.3	61.9	19.90	1758
72	95.1	85.5	327.3	65.3	61.9	20.27	1760
73	95.0	85.0	333.0	65.4	62.0	20.64	1762
74	94.8	84.5	338.6	65.5	62.0	21.00	1764
75	94.6	84.0	344.1	65.5	62.1	21.37	1766
76	94.5	83.5	349.7	65.6	62.2	21.73	1768
77	94.4	83.0	355.1	65.6	62.2	22.09	1770
78	94.2	82.5	360.6	65.7	62.3	22.45	1772
79	94.0	82.0	366.0	65.7	62.3	22.80	1774
80	93.8	81.5	371.3	65.8	62.4	23.16	1775
81	93.6	81.0	376.6	65.8	62.4	23.50	1776
82	93.5	80.5	381.9	65.8	62.5	23.85	1777
83	93.3	80.0	387.1	65.9	62.5	24.20	1778
84	93.2	79.4	392.3	65.9	62.5	24.54	1779
85	93.0	78.8	397.4	65.9	62.6	24.88	1780
86	92.8	78.2	402.5	66.0	62.6	25.21	1781
87	92.6	77.6	407.5	66.0	62.7	25.54	1782
88	92.4	76.9	412.5	66.0	62.7	25.87	1783
89	92.2	76.2	417.4	66.1	62.8	26.20	1784
90	92.1	75.5	422.3	66.1	62.8	26.52	1785
91	92.0	74.8	427.1	66.1	62.8	26.84	1786
92	91.8	74.1	431.9	66.1	62.9	27.15	1787
93	91.6	73.3	436.6	66.1	62.9	27.46	1788
94	91.4	72.5	441.2	66.1	62.9	27.77	1789
95	91.2	71.7	445.8	66.2	63.0	28.07	1790
96	91.0	70.9	450.3	66.2	63.0	28.37	1791
97	90.9	70.0	454.8	66.2	63.0	28.66	1792
98	90.7	69.1	459.2	66.2	63.1	28.96	1793
99	90.5	68.2	463.5	66.2	63.1	29.24	1794
100	90.3	67.3	467.7	66.2	63.1	29.52	1795

ACKNOWLEDGEMENT

We would like to thank following companies for sharing the pictures:

Dr. Mike Czarick from the University of Georgia

Novatech®

Dr. Susan Watkins

H&N GB

Hyline-Benelux

H&N Peninsular

Vencomatic

PPDA Poultry Vets

Big-Dutchman

De Heus

ZTHZ, Universität Bern

DISCLAIMER

The information, advices and suggestions given in this management guide should be used for guidance and educational purposes only, recognizing that local environmental and disease conditions may vary and a guide cannot cover all possible circumstances. While every attempt has been made to ensure that the information presented is accurate and reliable at the time of publication, H&N International

cannot accept responsibility for any errors, omissions or inaccuracies in such information or management suggestions.

Further, H&N International does not warrant or make any representations or guarantees regarding the use, validity, accuracy, or reliability of, or flock performance or productivity resulting from the use of, or otherwise respecting, such information

or management suggestions. In no event H&N International be liable for any special, indirect or consequential damages or special damages whatsoever arising out of or in connection with the use of the information or management suggestions containing in this management guide.



IMPRINT

Editor
H&N International GmbH
Am Seedeich 9 | 27472 Cuxhaven | Germany
Phone +49 (0)4721 564-0
E-mail: info@hn-int.com | Internet: www.hn-int.com
Photo credits
H&N International GmbH

© H&N International
All rights reserved. Reproduction in whole or in part is
only permitted with referencing the source.